

CLUB Floor

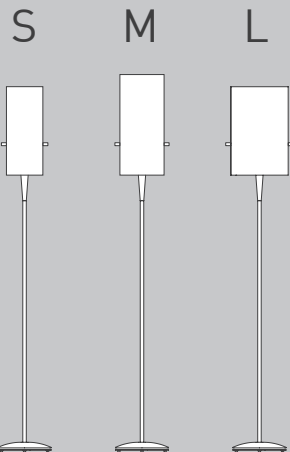

Design Jean-Marc da Costa

D

Vor Montage, Leuchtmittelwechsel und Reinigung Leuchte vom Netz trennen!
Die Leuchte nur im Innenbereich einsetzen! Nur von Elektrofachkraft anzuschließen!

GB

Prior to assembly, changing the lamp or cleaning the luminaire please detach it from the mains. For indoor use only. Installation by qualified personnel only.

F

Prière de couper le courant avant tout montage, changement d'ampoule et nettoyage.
Ce luminaire est réservé à un usage en intérieur. Installation par personnel qualifié uniquement.

I

Scollegare la lampada dalla rete elettrica prima del montaggio, della sostituzione del corpo illuminante e della pulizia. La lampada è adatta esclusivamente per interni. Installazione da personale qualificato solo.

E

Antes de proceder al montaje, el cambio de bombilla y la limpieza desconecte la lámpara de la red eléctrica. Instale la lámpara sólo en un lugar interior. Instalación solamente por personal calificado.

NL

Voor montage, vervanging en reiniging de lamp van het stroomnet loskoppelen.
De lamp alleen binnen gebruiken. Om alleen te verbinden door een erkend elektricien.

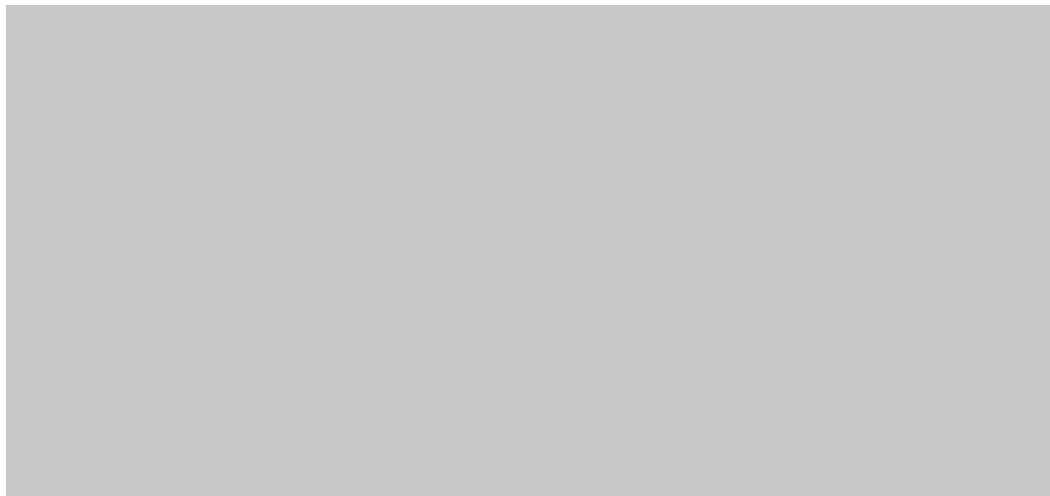

01

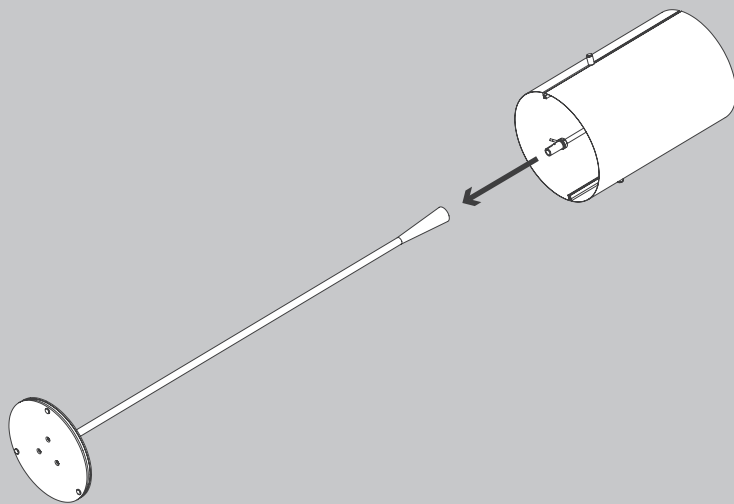

02

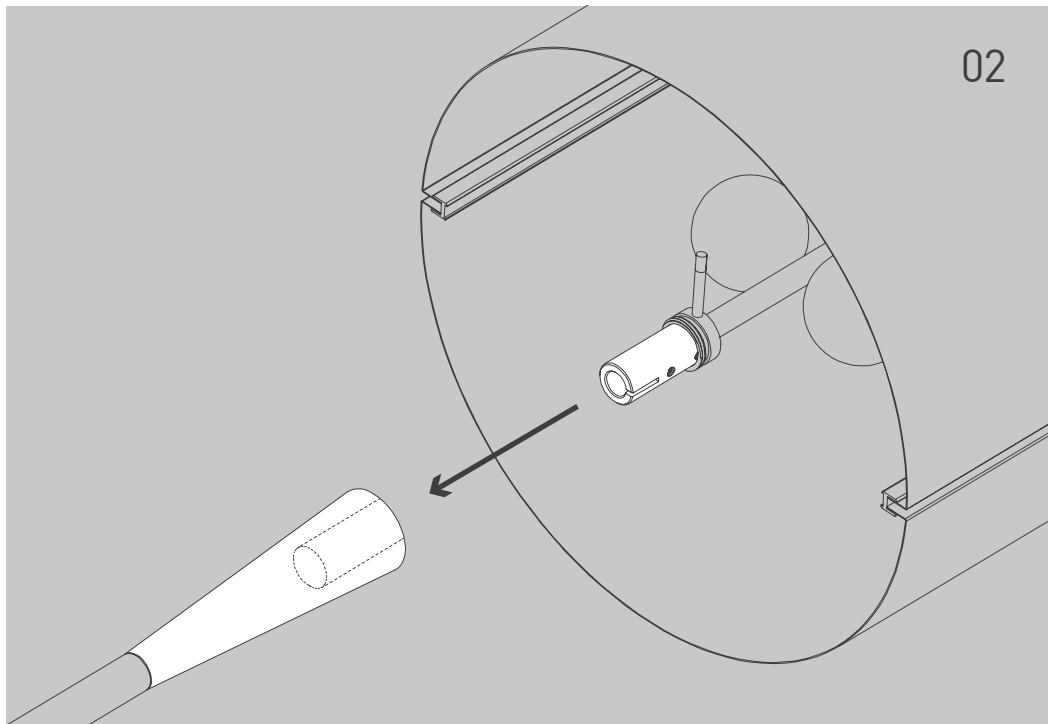

03

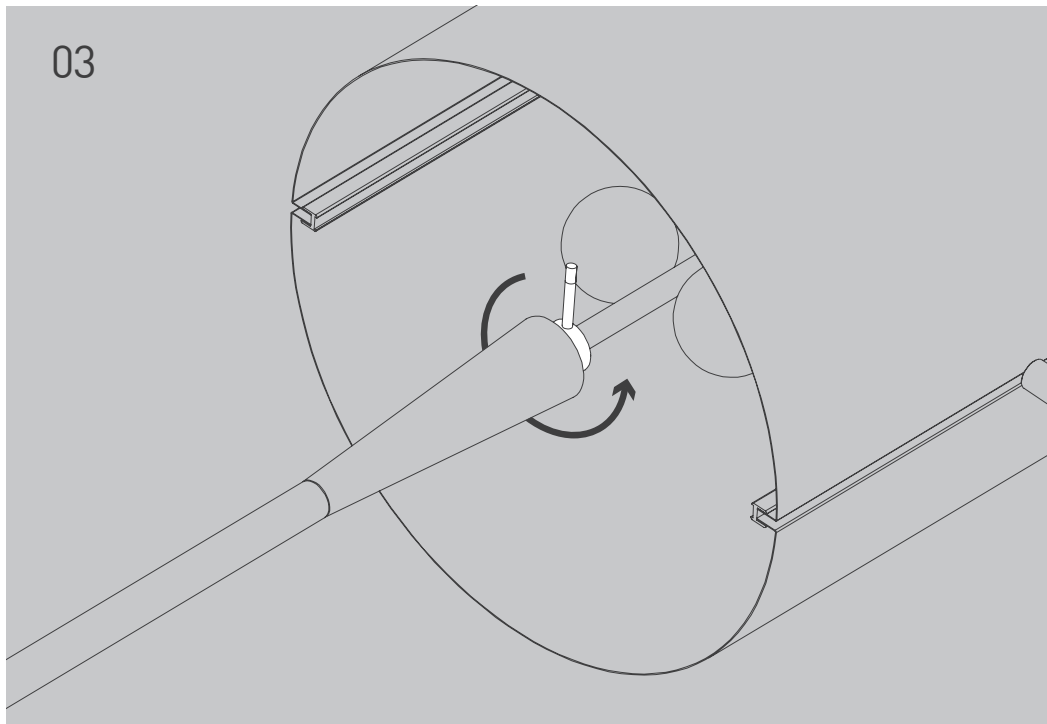

04



05

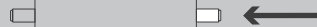
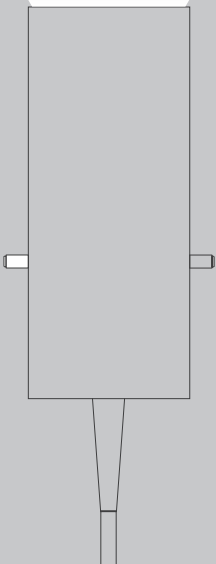

< 0,5 s ON/OFF

> 0,5 s 

06

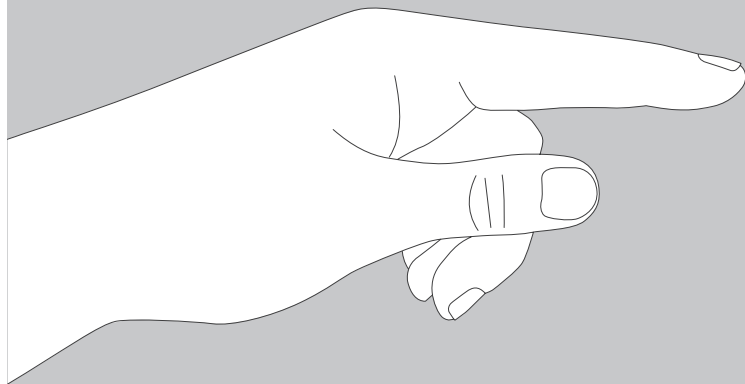



Die durchgestrichene Mülltonne weist darauf hin, dass dieses Elektrogerät nicht im Hausmüll entsorgt werden darf.

Um die menschliche Gesundheit und die Umwelt vor möglichen Gefahrstoffen zu schützen, kann dieses Produkt am Ende seiner Lebensdauer kostenfrei bei einer Sammelstelle in Ihrer Nähe abgegeben werden.

Die gesonderte Entsorgung ermöglicht die Wiederverwendung bzw. Verwertung von Elektrogeräten.

- D** Technische Änderungen und Irrtümer vorbehalten.
- GB** Subject to technical modifications and errors.
- F** Sous réserve de modifications techniques et d'erreurs.
- I** Ci riserviamo eventuali modifiche tecniche o errori.
- E** Se reserva el derecho a realizar modificaciones técnicas.
- NL** Error en technische wijzigingen voorbehouden.

CLUB Floor S, M, L

mm

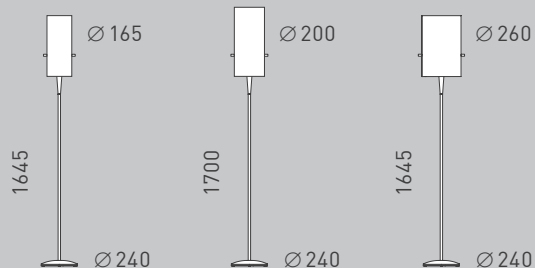

kg

4,5 kg



20 W (up 1x10 W / down 2x5 W)

primär/primary 220 - 240V, 50 - 60Hz

EEK/EEC

Dieses Produkt enthält drei Lichtquellen der Energieeffizienzklasse E.
This product contains three light sources of energy efficiency class E.

IP20



serien
.lighting

serien Raumleuchten GmbH Hainhäuser Str. 3-7 63110 Rodgau, Germany Tel +49 (0)6106 6909 0 www.serien.com