

# DRAFT

## Data Sheet

Suspension Rope



DRAFT Suspension Rope S and M - clear

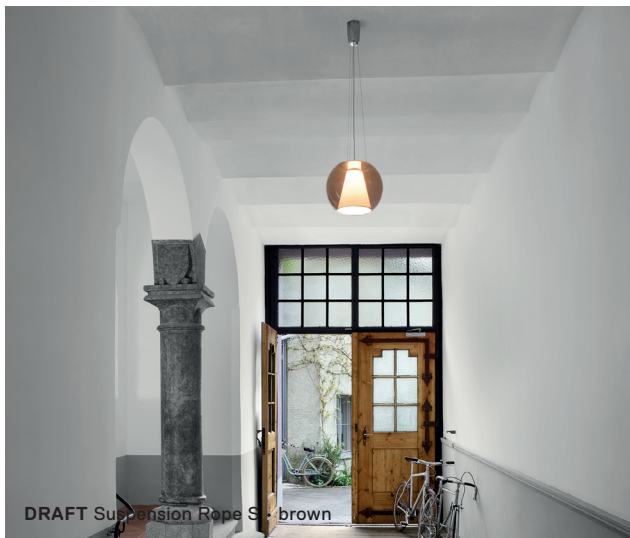

DRAFT Suspension Rope S - brown



DRAFT Suspension Rope M - clear

DRAFT turns the archetypical spherical luminaire into an object that boasts an unpretentious contemporary look and perfectly balanced light: DRAFT combines diffuse ambient light with a direct, softly diffused all-round and downward directional light.

Examples of applications: DRAFT Suspension Tube with its classic ball luminaire tube suspension, complements the architecture more strongly, whereas with its wire rope suspension, DRAFT Suspension Rope can be hung deep in a space, as low as over a coffee table. A staggered group of DRAFT Suspension luminaires becomes an eye-catching arrangement in lounges, above tables or on stairs and in foyers.

Design Jean-Marc da Costa

### Material

#### Surfaces



glass shad clear

glass shad brown

glass shad blue

#### Housing

Aluminum mirror polished

#### Shade

Mouth blown glass

#### Reflector

Polycarbonate opal

### Variations

#### Dimensions in mm

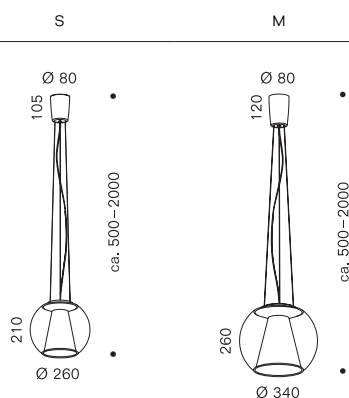

#### Weight

1,5 kg

3,0 kg

### LED

| Light color | Color rendering Index CRI | Color consistency | Luminous flux  | Energy efficiency class |
|-------------|---------------------------|-------------------|----------------|-------------------------|
| 2700 K      | >97                       | 2 Step            | 111 lm/W       | E                       |
| 3000 K      | >97                       | 2 Step            | 116 lm/W       | E                       |
| S Dim2Warm  | >95                       | 3 Step            | up to 97 lm/W  | F                       |
| M Dim2Warm  | >95                       | 3 Step            | up to 101 lm/W | F                       |

Other versions (CCT/CRI) available on request.  
 LED light source replaceable by professionals  
 Average life 50,000 h (specification according to manufacturer).

### Control gear

| Control | Connected load | Operating voltage | Constant current / voltage | Feature             |
|---------|----------------|-------------------|----------------------------|---------------------|
| S TRIAC | 11 W           | 230 V AC / 50 Hz  | 300 mA / 35 V              | dimnable            |
| S DALI  | 11 W           | 230 V AC / 50 Hz  | 300 mA / 35 V              | dimnable, Touch DIM |
| M TRIAC | 27 W           | 230 V AC / 50 Hz  | 700 mA / 35 V              | dimnable            |
| M DALI  | 27 W           | 230 V AC / 50 Hz  | 700 mA / 35 V              | dimnable, Touch DIM |

Control gear replaceable by professionals  
 The luminaire may be operated at a maximum of the constant current specified above.



### Photometric data sheet

#### DRAFT Suspension Rope S glass clear

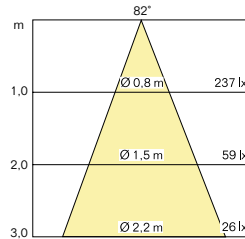
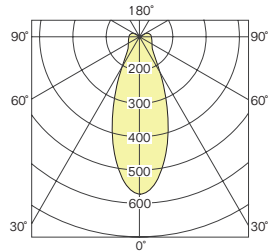

UGR ≤ 14

Light: directed downwards,  
diffuse all around

| Power | CRI            | CCT    | Luminous flux<br>(measured value) |
|-------|----------------|--------|-----------------------------------|
| 11 W  | Ra>97<br>R9>80 | 2700 K | 780 lm                            |
|       |                | 3000 K | 820 lm                            |

#### DRAFT Suspension Rope S glass brown

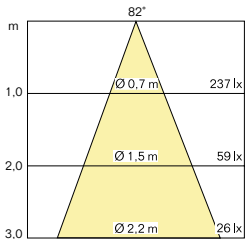
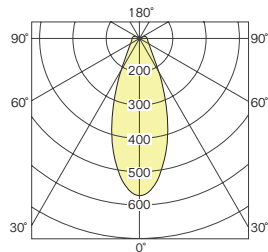

UGR ≤ 14

Light: directed downwards,  
diffuse all around

|      |                |        |        |
|------|----------------|--------|--------|
| 11 W | Ra>97<br>R9>80 | 2700 K | 670 lm |
|      |                | 3000 K | 710 lm |

#### DRAFT Suspension Rope S glass blue

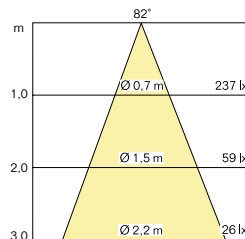
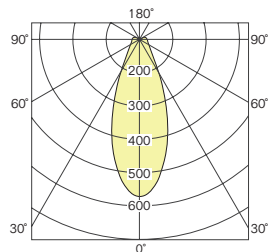

UGR ≤ 14

Light: directed downwards,  
diffuse all around

|      |                |        |        |
|------|----------------|--------|--------|
| 11 W | Ra>97<br>R9>80 | 2700 K | 670 lm |
|      |                | 3000 K | 710 lm |

 Note: The photometric data (EULUMDAT) can be downloaded from <https://serien.com/downloads/>

### Photometric data sheet

#### DRAFT Suspension Rope M glass clear

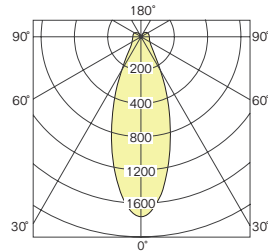

LOR = 61%

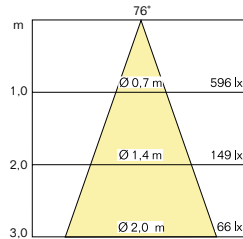

UGR ≤ 14

Power      CRI      CCT      Luminous flux  
(measured value)

|      |                |        |         |
|------|----------------|--------|---------|
| 20 W | Ra>97<br>R9>80 | 2700 K | 1810 lm |
|      |                | 3000 K | 1900 lm |

Light: directed downwards,  
diffuse all around

#### DRAFT Suspension Rope M glass brown

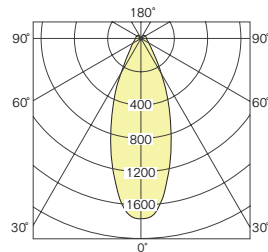

LOR = 61%

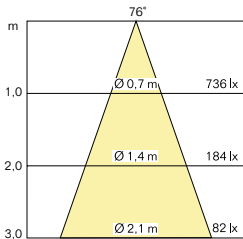

UGR ≤ 14

|      |                |        |         |
|------|----------------|--------|---------|
| 20 W | Ra>97<br>R9>80 | 2700 K | 1560 lm |
|      |                | 3000 K | 1640 lm |

Light: directed downwards,  
diffuse all around

#### DRAFT Suspension Rope M glass blue

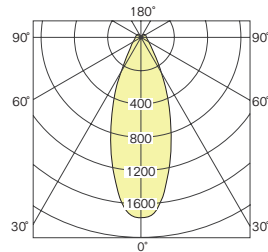

LOR = 61%

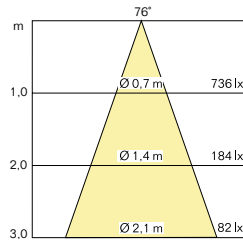





UGR ≤ 14

|      |                |        |         |
|------|----------------|--------|---------|
| 20 W | Ra>97<br>R9>80 | 2700 K | 1560 lm |
|      |                | 3000 K | 1640 lm |





Light: directed downwards,  
diffuse all around

⬇️ Note: The photometric data (EULUMDAT) can be downloaded from <https://serien.com/downloads/>

### DRAFT Suspension S



| figure  | description                | lamp | control | power | CCT            | art.-no. |                |          |
|---|----------------------------|------|---------|-------|----------------|----------|----------------|----------|
|  | Rope lighting unit         | LED  | TRIAC   | 11 W  | 2700K          | LE015704 |                |          |
|   |                            |      |         |       | 3000K          | LE015705 |                |          |
|   |                            |      |         |       | 1800–3000K D2W | LE015706 |                |          |
|   |                            |      |         |       | DALI           | 11 W     | 2700K          | LE015735 |
|   |                            |      |         |       |                |          | 3000K          | LE015736 |
|   |                            |      |         |       |                |          | 1800–3000K D2W | LE015737 |
|  | glass clear with reflector |      |         |       |                | DR015728 |                |          |
|  | glass brown with reflector |      |         |       |                | DR015729 |                |          |
|  | glass blue with reflector  |      |         |       |                | DR015730 |                |          |

### DRAFT Suspension M

| figure  | description                | lamp | control | power | CCT            | art.-no. |                |          |
|---|----------------------------|------|---------|-------|----------------|----------|----------------|----------|
|  | Rope lighting unit         | LED  | TRIAC   | 27 W  | 2700K          | LE015716 |                |          |
|   |                            |      |         |       | 3000K          | LE015717 |                |          |
|   |                            |      |         |       | 1800–3000K D2W | LE015718 |                |          |
|   |                            |      |         |       | DALI           | 27 W     | 2700K          | LE015719 |
|   |                            |      |         |       |                |          | 3000K          | LE015720 |
|   |                            |      |         |       |                |          | 1800–3000K D2W | LE015721 |
|  | glass clear with reflector |      |         |       |                | DR015731 |                |          |
|  | glass brown with reflector |      |         |       |                | DR015732 |                |          |
|  | glass blue with reflector  |      |         |       |                | DR015733 |                |          |

DRAFT is a modular article. Please order the lighting unit and glass shade together.

## Information

|   |   |
|---|---|
| + C   | +C indicates products with pre-programmed CASAMBI module integrated in the luminaire. The CASAMBI functionality is basically applicable to all our products. For the different possibilities of integration (depending on the temperature) – in the luminaire, in the suspended ceiling, in the switch or the distribution box) we will be pleased to inform you. CASAMBI is a lighting control system which is operated via Bluetooth and can be integrated completely into the luminaire or behind the light switch. It is controlled via mobile devices using the free CASAMBI app, making its operation simple and intuitive. CASAMBI expands the possibilities of control with new options such as dimming, the programming of specific scenarios or groups, automations and many more. For further information, please visit <a href="http://www.casambi.com">www.casambi.com</a> . |
| CCT   | CCT (Correlated Color Temperature) is the colour temperature of an LED and is specified in Kelvin (K).<br>We supply LED lights with a colour temperature of 2700 K at short notice.<br>LED lights with a color temperature of 3000 K and higher usually have longer delivery times.   |
| CRI   | Colour Rendering Index  |
| D2W   | Dim2Warm refers to a luminaire functionality that imitates the pleasant dimming behavior of classic incandescent lamps. When dimmed, the light not only becomes darker, but also changes its colour to warm white tone.   |
| DALI 1-10 V   | 5-core mains cable required for control via DALI or 1–10 V.<br>All LED luminaires operated with DALI power supply units are suitable for use in emergency lighting systems.   |
| Lumen   | The luminous flux (lumen) specifications are nominal values, i.e. pure module luminous flux values.<br>The luminous flux indicates how much light radiates in all directions.   |
| TW  | Luminaires with this characteristic have variable colour temperature control from warm to cool white light.   |
| UGR   | Unified Glare Rating  |
| IP  | Protection class  |
| LOR   | The luminaire operating efficiency is given as a LOR value (Light Output Ratio) in percent.   |
|  | The crossed-out wheellie bin indicates that this electrical appliance must not be disposed of via household waste.<br>In order to protect human health and the environment against potentially hazardous substances, at the end of its lifecycle this product can be taken to a collection point close to you and disposed of free of charge there.<br>This separate disposal enables electrical appliances to be reused or recycled.   |
|  | <b>At <a href="http://www.serien.com/downloads">www.serien.com/downloads</a></b> you will find helpful information and the latest technical data:<br>Data sheets, catalogues, price lists, lighting data (EULUMDAT), 3D CAD data, EU Energy labels, declarations of conformity, returns form, FAQs, assembly instructions, drilling templates and other service instructions.   |
| ✓   | This data sheet supersedes all previously published data sheet. The drawings shown in this document are for informational purposes only. Although great care has been taken when creating them, their proportions may not correctly reflect the proportions of the real product.  |
|   | All values are rated values. Power and luminous flux are subject to an initial tolerance of +/- 10%.<br>Tolerance of color temperature: +/-150 K. When not otherwise indicated the values apply for an ambient temperature of 25 °C.<br>The specified nominal and measured values refer to the illuminants used at the time the data sheet was prepared. Omissions excepted.  |

## Imprint

serien Raumluchten GmbH, HRB 22042 Amtsgericht Offenbach. Managing Directors: Jean-Marc da Costa, Manfred Wolf. All rights reserved.  
No reproductions without prior written consent. All trademarks are registered. All products are protected by law. Infringements will be prosecuted to the fullest extent. Subject to alteration without notice.