

2023/24

deutsch  
international

# LIVING THE LIGHT

serien  
.lighting

Ceiling	<b>ANNEX</b>	4
	<b>CAVITY</b>	6
	<b>CURLING</b>	8
	<b>DRAFT</b>	12
	<b>DRUM</b>	14
	<b>POPPY</b>	16
	<b>REEF</b>	11
	<b>REFLEX<sup>2</sup></b>	19
	<b>SLICE<sup>2</sup> PI</b>	24
Suspension	<b>ANNEX</b>	58
	<b>CAVITY</b>	60
	<b>CURLING</b>	62
	<b>DRAFT</b>	66
	<b>DRUM</b>	68
	<b>ONE EIGHTY</b>	70
	<b>POPPY</b>	72
	<b>PROPELLER</b>	73
	<b>REEF</b>	74
	<b>TWIN</b>	75
	<b>ZOOM</b>	76
	<b>ZOOM XL</b>	76
	Wall	<b>APP</b>
<b>CAVITY</b>		105
<b>CLUB</b>		106
<b>CRIB</b>		107
<b>CURLING</b>		108
<b>LID</b>		110
<b>POPPY</b>		112
<b>REEF</b>		115
<b>REFLEX<sup>2</sup></b>		116
<b>ROD</b>		117
<b>SML</b>		118
<b>SML<sup>2</sup></b>		120
Table		<b>JOB</b>
	<b>POPPY</b>	156
	<b>REFLEX<sup>2</sup></b>	157
	<b>SLICE<sup>2</sup></b>	158
Floor	<b>CLUB</b>	169
	<b>JONES</b>	171
	<b>POPPY</b>	172
	<b>REFLEX<sup>2</sup></b>	174
	<b>SLICE<sup>2</sup></b>	176

Info	Information	205
	Awards	206
	Contacts	207
	Imprint	208

Accessories	Baldachinprofile / Canopy profiles	198
	Ersatzbezug / Replacement cover	200
	Kristallglas Anhänger / Crystal glas pendant	200
	Optiken / Optics	201
	Spiegel Adapter Set / Mirror adapter set	201
	Wandadapter / Wall adapters	202
	Wandabdeckungen / Wall cover	203





**ANNEX**  
S. 4



**CAVITY**  
S. 6

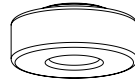

**CURLING**  
S. 8

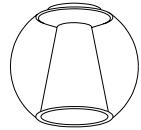

**DRAFT**  
S. 12

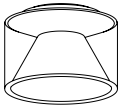

**DRUM**  
S. 14

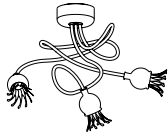

**POPPY**  
S. 16



**REEF**  
S. 11

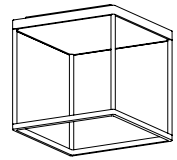

**REFLEX<sup>2</sup>**  
S. 19



**SLICE<sup>2</sup> PI**  
S. 24



## ANNEX Ceiling

Eine geradezu archetypische Deckenleuchte mit dem Mehr an Funktionalität, auf das wir Wert legen: drei verschiedene Größen korrespondieren mit den Proportionen Ihrer Räume. Mit den unterschiedlichen Reflektoren im Innern des mundgeblasenen Kegelschirms lassen sich äußerst differenzierte Lichtwirkungen erzielen, die formal dennoch einer Familie angehören.

A quite archetypal ceiling lamp with that added functionality we value: three different sizes correspond with the proportions of your rooms. The different reflectors on the inside of the hand-blown spherical shade enable extremely varied light effects, which nonetheless formally are part of one family.

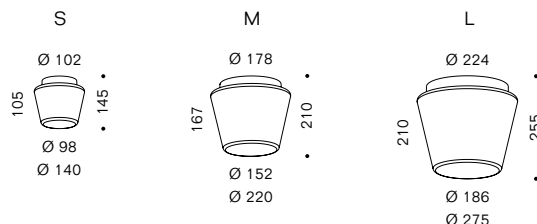

**Leuchtmittel** LED 9–41 W, CoB, CRI Ra>97 (R9>80), EEK/EEC E (3000 K), F (2700 K)  
**lamp** S: G9, M: B15d, L: E27, EEK/EEC G (M, L: Lieferung ohne Leuchtmittel/delivery without bulb)

**Leuchteneinheit** Aluminium, hochglanzpoliert und weiß beschichtet  
**lighting unit** aluminum, highly polished coated white

**Schirm** mundgeblasenes Glas klar  
**shade** hand-blown glass clear

**Ausführungen**  
**versions**



**Glasschirm klar, Reflektor Acrylglas opal**  
**Licht: nach unten gerichtet, rundum gestreut**  
 glass shade clear, reflector acrylic glass opal  
 light: directed downwards, distributed all around





**Glasschirm klar, Reflektor Aluminium poliert**  
**Licht: nach unten gerichtet, rundum diffus**  
 glass shade clear, reflector: aluminium polished  
 light: directed downwards, diffused all around





**Glasschirm klar, Reflektor Kristallglas geschliffen mit Aluminium-Innenreflektor**  
**Licht: nach unten gerichtet, rundum dekorativ**  
 glass shade clear, reflector crystal glass with aluminium reflector  
 light: directed downwards, diffused all around

**Sonstiges** LED austauschbar; werkzeuglose Schirmmontage; 110 V-Varianten auf Anfrage  
**features** LED exchangeable; glass shade tool-free mountable; 110 V versions on request



## ANNEX Ceiling S

Abbildung figure	Beschreibung description	Leuchtmittel lamp	Regelung control	Leistung power	CCT	Lumen lumen	Art.-Nr. art.-no.	€ netto DE excl. VAT	€ brutto DE incl. VAT
	<b>Reflektor opal</b> reflector opal	LED	TRIAC	9 W	2700 K	1020 lm	AN3201	336,13 €	400,00 €
					3000 K	1060 lm	AN3202	336,13 €	400,00 €
		G9	TRIAC	max. 60 W	2700 K	980 lm	AN1013	260,50 €	310,00 €
	<b>Reflektor poliert</b> reflector polished	LED	TRIAC	9 W	2700 K	1020 lm	AN3211	361,34 €	430,00 €
					3000 K	1060 lm	AN3212	361,34 €	430,00 €
		G9	TRIAC	max. 60 W	2700 K	980 lm	AN1121	281,51 €	335,00 €
	<b>Reflektor Kristall</b> reflector crystal	LED	TRIAC	9 W	2700 K	1020 lm	AN3221	428,57 €	510,00 €
					3000 K	1060 lm	AN3222	428,57 €	510,00 €
		G9	TRIAC	max. 60 W	2700 K	980 lm	AN1043	352,94 €	420,00 €

## ANNEX Ceiling M

Abbildung figure	Beschreibung description	Leuchtmittel lamp	Regelung control	Leistung power	CCT	Lumen lumen	Art.-Nr. art.-no.	€ netto DE excl. VAT	€ brutto DE incl. VAT	
	<b>Reflektor opal</b> reflector opal	LED	TRIAC	20 W	2700 K	1450 lm	AN3001	457,98 €	545,00 €	
					3000 K	1500 lm	AN3002	457,98 €	545,00 €	
			B15d	DALI	27 W	2700 K	2900 lm	AN3006	491,60 €	585,00 €
						3000 K	3000 lm	AN3007	491,60 €	585,00 €
						2800 K	1800 lm	AN1066	336,13 €	400,00 €
	<b>Reflektor poliert</b> reflector polished	LED	TRIAC	20 W	2700 K	1450 lm	AN3011	491,60 €	585,00 €	
					3000 K	1500 lm	AN3012	491,60 €	585,00 €	
			B15d	DALI	27 W	2700 K	2900 lm	AN3015	525,21 €	625,00 €
						3000 K	3000 lm	AN3016	525,21 €	625,00 €
						2800 K	1800 lm	AN1078	369,75 €	440,00 €
	<b>Reflektor Kristall</b> reflector crystal	LED	TRIAC	20 W	2700 K	1450 lm	AN3021	596,64 €	710,00 €	
					3000 K	1500 lm	AN3022	596,64 €	710,00 €	
			B15d	DALI	27 W	2700 K	2900 lm	AN3025	630,25 €	750,00 €
						3000 K	3000 lm	AN3026	630,25 €	750,00 €
						2800 K	1800 lm	AN1073	474,79 €	565,00 €

## ANNEX Ceiling L

Abbildung figure	Beschreibung description	Leuchtmittel lamp	Regelung control	Leistung power	CCT	Lumen lumen	Art.-Nr. art.-no.	€ netto DE excl. VAT	€ brutto DE incl. VAT	
	<b>Reflektor opal</b> reflector opal	LED	TRIAC	34 W	2700 K	3850 lm	AN3047	529,41 €	630,00 €	
					3000 K	4010 lm	AN3048	529,41 €	630,00 €	
			E27	DALI	41 W	2700 K	4500 lm	AN3051	571,43 €	680,00 €
						3000 K	4680 lm	AN3052	571,43 €	680,00 €
						2900 K	2870 lm	AN1067	424,37 €	505,00 €
	<b>Reflektor poliert</b> reflector polished	LED	TRIAC	34 W	2700 K	3850 lm	AN3053	571,43 €	680,00 €	
					3000 K	4010 lm	AN3054	571,43 €	680,00 €	
			E27	DALI	41 W	2700 K	4500 lm	AN3057	613,45 €	730,00 €
						3000 K	4680 lm	AN3058	613,45 €	730,00 €
						2900 K	2870 lm	AN1079	470,59 €	560,00 €
	<b>Reflektor Kristall</b> reflector crystal	LED	TRIAC	34 W	2700 K	3850 lm	AN3041	731,09 €	870,00 €	
					3000 K	4010 lm	AN3042	731,09 €	870,00 €	
			E27	DALI	41 W	2700 K	4500 lm	AN3045	773,11 €	920,00 €
						3000 K	4680 lm	AN3046	773,11 €	920,00 €
						2900 K	2870 lm	AN1074	613,45 €	730,00 €

## CAVITY Ceiling & Recessed

Ein speziell konzipierter, kurvenförmiger Aluminiumkörper mit vertieft sitzendem Leuchtmittel ersetzt beim Strahler CAVITY den Reflektor und erlaubt eine freie Entfaltung des Lichts, das über die Trichterform scheinbar nach außen fließt. Es entsteht ein Downlight mit einem blendfreien und sanften Licht, das aus jedem Winkel angenehm wirkt. Unterschiedliche Beleuchtungsaufgaben können einheitlich durch Kombination von Aufbau- und Einbaustrahlern mit den Pendelleuchten sowie den Wandleuchten dieser Produktfamilie gelöst werden.



A specially designed, curved aluminum body including the recessed illuminant replaces the reflector in spotlight CAVITY and allows the light to unfold freely, seemingly flowing outwards via the funnel shaped form. The result is a glare-free and soft downlight, that is pleasant from all angles. Different lighting tasks can be solved consistently by combining the surface-mounted and recessed spotlights with the pendant luminaires and wall luminaires of this product family.

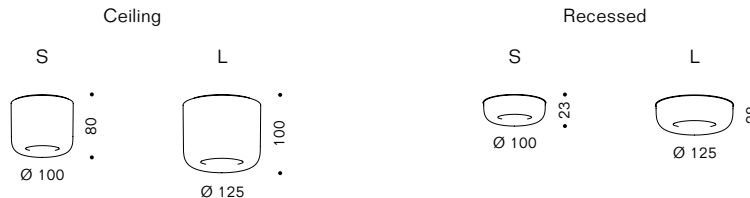

**Licht**  
light **nach unten gerichtet, seitlich abgeschirmt**  
directed downwards, shielded to the sides

**Leuchtmittel**  
lamp LED 10–20 W, CoB, CRI Ra>95 (R9>80), EEK/EEC E

**Gehäuse**  
housing **Aluminium schwarz oder weiß beschichtet, Aluminiumglanz finish oder Bronze finish**  
aluminum black or white coated, aluminum gloss finish or bronze finish

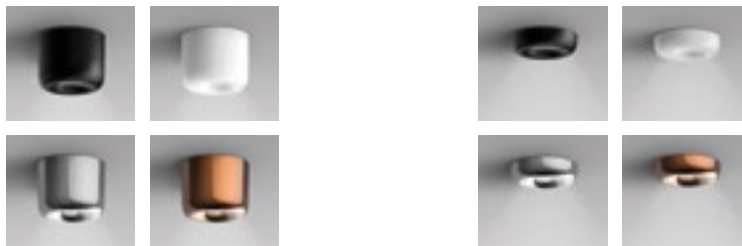

**Sonstiges**  
features **LED wechselbar, werkzeuglose Gehäusemontage; Recessed Varianten benötigen eine Bauraumhöhe oberhalb der Deckenunterkante von: S/L TRIAC >45 mm, S DALI >85 mm, L DALI >65 mm; 110 V-Varianten auf Anfrage**  
LED exchangeable, housing tool-free mountable; recessed variants require an installation space above the lower edge of the ceiling of: S/L TRIAC >45 mm, S DALI >85 mm, L DALI >65 mm; 110 versions on request

## CAVITY Ceiling S

Abbildung figure	Beschreibung description	Leuchtmittel lamp	Regelung control	Leistung power	CCT	Lumen lumen	Art.-Nr. art.-no.	€ netto DE excl. VAT	€ brutto DE incl. VAT
●	<b>schwarz</b> black	LED	TRIAC	10 W	2700 K	950 lm	CA1001	184,87 €	220,00 €
					3000 K	1000 lm	CA1002	184,87 €	220,00 €
○	<b>weiß</b> white	LED	TRIAC	10 W	2700 K	950 lm	CA1003	184,87 €	220,00 €
					3000 K	1000 lm	CA1004	184,87 €	220,00 €
●	<b>Aluminiumglanz finish</b> aluminum gloss finish	LED	TRIAC	10 W	2700 K	950 lm	CA1005	214,29 €	255,00 €
					3000 K	1000 lm	CA1006	214,29 €	255,00 €
●	<b>Bronze finish</b> bronze finish	LED	TRIAC	10 W	2700 K	950 lm	CA1007	214,29 €	255,00 €
					3000 K	1000 lm	CA1008	214,29 €	255,00 €

## CAVITY Ceiling L

Abbildung figure	Beschreibung description	Leuchtmittel lamp	Regelung control	Leistung power	CCT	Lumen lumen	Art.-Nr. art.-no.	€ netto DE excl. VAT	€ brutto DE incl. VAT
●	schwarz black	LED	TRIAC	20 W	2700 K	1910 lm	CA2001	239,50 €	285,00 €
					3000 K	2010 lm	CA2002	239,50 €	285,00 €
			DALI	20 W	2700 K	1910 lm	CA2005	289,92 €	345,00 €
					3000 K	2010 lm	CA2006	289,92 €	345,00 €
○	weiß white	LED	TRIAC	20 W	2700 K	1910 lm	CA2007	239,50 €	285,00 €
					3000 K	2010 lm	CA2008	239,50 €	285,00 €
			DALI	20 W	2700 K	1910 lm	CA2011	289,92 €	345,00 €
					3000 K	2010 lm	CA2012	289,92 €	345,00 €
●	Aluminiumglanz finish aluminum gloss finish	LED	TRIAC	20 W	2700 K	1910 lm	CA2013	277,31 €	330,00 €
					3000 K	2010 lm	CA2014	277,31 €	330,00 €
			DALI	20 W	2700 K	1910 lm	CA2017	327,73 €	390,00 €
					3000 K	2010 lm	CA2018	327,73 €	390,00 €
●	Bronze finish bronze finish	LED	TRIAC	20 W	2700 K	1910 lm	CA2019	277,31 €	330,00 €
					3000 K	2010 lm	CA2020	277,31 €	330,00 €
			DALI	20 W	2700 K	1910 lm	CA2023	327,73 €	390,00 €
					3000 K	2010 lm	CA2024	327,73 €	390,00 €

## CAVITY Recessed S

Abbildung figure	Beschreibung description	Leuchtmittel lamp	Regelung control	Leistung power	CCT	Lumen lumen	Art.-Nr. art.-no.	€ netto DE excl. VAT	€ brutto DE incl. VAT
●	schwarz black	LED	TRIAC	10 W	2700 K	1120 lm	CA1301	172,27 €	205,00 €
					3000 K	1180 lm	CA1302	172,27 €	205,00 €
○	weiß white	LED	TRIAC	10 W	2700 K	1120 lm	CA1303	172,27 €	205,00 €
					3000 K	1180 lm	CA1304	172,27 €	205,00 €
●	Aluminiumglanz finish aluminum gloss finish	LED	TRIAC	10 W	2700 K	1120 lm	CA1305	197,48 €	235,00 €
					3000 K	1180 lm	CA1306	197,48 €	235,00 €
●	Bronze finish bronze finish	LED	TRIAC	10 W	2700 K	1120 lm	CA1307	197,48 €	235,00 €
					3000 K	1180 lm	CA1308	197,48 €	235,00 €

## CAVITY Recessed L

Abbildung figure	Beschreibung description	Leuchtmittel lamp	Regelung control	Leistung power	CCT	Lumen lumen	Art.-Nr. art.-no.	€ netto DE excl. VAT	€ brutto DE incl. VAT
●	schwarz black	LED	TRIAC	20 W	2700 K	1910 lm	CA2301	226,89 €	270,00 €
					3000 K	2010 lm	CA2302	226,89 €	270,00 €
			DALI	20 W	2700 K	1910 lm	CA2305	277,31 €	330,00 €
					3000 K	2010 lm	CA2306	277,31 €	330,00 €
○	weiß white	LED	TRIAC	20 W	2700 K	1910 lm	CA2307	226,89 €	270,00 €
					3000 K	2010 lm	CA2308	226,89 €	270,00 €
			DALI	20 W	2700 K	1910 lm	CA2311	277,31 €	330,00 €
					3000 K	2010 lm	CA2312	277,31 €	330,00 €
●	Aluminiumglanz finish aluminum gloss finish	LED	TRIAC	20 W	2700 K	1910 lm	CA2313	264,71 €	315,00 €
					3000 K	2010 lm	CA2314	264,71 €	315,00 €
			DALI	20 W	2700 K	1910 lm	CA2317	315,13 €	375,00 €
					3000 K	2010 lm	CA2318	315,13 €	375,00 €
●	Bronze finish bronze finish	LED	TRIAC	20 W	2700 K	1910 lm	CA2319	264,71 €	315,00 €
					3000 K	2010 lm	CA2320	264,71 €	315,00 €
			DALI	20 W	2700 K	1910 lm	CA2323	315,13 €	375,00 €
					3000 K	2010 lm	CA2324	315,13 €	375,00 €

# CURLING Ceiling

Klare Formen und intelligente Gestaltungsdetails machen CURLING Ceiling zum universell einsetzbaren Downlight und Deckenlicht in einem. Das ermöglicht in jeder Raumsituation eine perfekte Lichtstimmung. CURLING Ceiling kombiniert nach unten gerichtetes Direktlicht mit sanft abstrahlendem Raumlicht. Versionen mit Acrylglasschirm in kantiger Ästhetik erweitern das Einsatzspektrum von CURLING und ermöglichen einen optimalen Einsatz in Schulen, Kindergärten, Treppenhäusern und anderen Verkehrswegen im halböffentlichen oder öffentlichen Raum.



With its clear shape and intelligent design CURLING Ceiling is an all-round downlight and ceiling light rolled into one. This allows the creation of a perfect lighting mood in any room situation. CURLING Ceiling combines light directed downward with softly diffusing ambient light. Versions with acrylic glass shade in angular aesthetics expand CURLING's range of applications and enable optimal use in schools, kindergartens, stairwells and other paths in semi-public and public spaces.

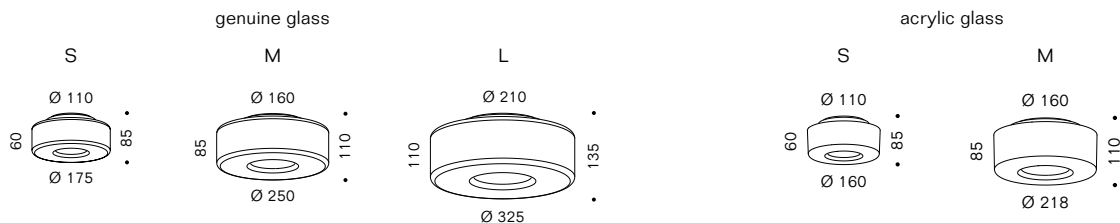

**Leuchtmittel lamp** LED 11–34 W, CoB, CRI Ra>97 (R9>80), EEK/EEC F (2700 K, 3000 K), G (1800–3000 K D2W)

**Leuchteneinheit lighting unit** Aluminium hochglanzpoliert  
aluminum highly polished

**Schirm shade**

<b>mundgeblasenes Glas klar, opal oder metallisiert</b> <b>Reflektor: Polycarbonat opal</b> hand-blown glass clear, opal or metallised reflector: polycarbonate opal	<b>Acrylglas klar</b> <b>Reflektor: Polycarbonat opal</b> Acrylic glass clear reflector: polycarbonate opal
---	--

**Ausführungen versions**



**Glasschirm klar**  
**Licht: nach unten gerichtet, rundum abstrahlend**  
glass shade clear  
light: directed downwards, distributed all around



**Acrylglasschirm klar**  
**Licht: nach unten gerichtet, rundum abstrahlend**  
acrylic glass shade clear  
light: directed downwards, distributed all around



**Glasschirm klar, Reflektor konisch**  
**Licht: nach unten gerichtet, rundum weich gestreut**  
glass shade clear, reflector conical  
light: directed downwards, diffused all around



**Acrylglasschirm klar, Reflektor konisch**  
**Licht: nach unten gerichtet, rundum weich gestreut**  
acrylic glass shade clear, reflector conical  
light: directed downwards, diffused all around



**Glasschirm klar, Reflektor zylindrisch**  
**Licht: nach unten gerichtet, rundum weich gestreut**  
glass shade clear, reflector cylindrical  
light: directed downwards, diffused all around



**Acrylglasschirm klar, Reflektor zylindrisch**  
**Licht: nach unten gerichtet, rundum weich gestreut**  
acrylic glass shade clear, reflector cylindrical  
light: directed downwards, diffused all around



**Glasschirm opal**  
**Licht: nach unten gerichtet, rundum weich gestreut**  
glass shade opal  
light: directed downwards, diffused all around











**Glasschirm neusilber**  
**Licht: nach unten gerichtet, rundum abstrahlend**  
glass shade new silver  
light: directed downwards, distributed all around

**Sonstiges features** LED wechselbar, werkzeuglose Schirmmontage; 110 V-Varianten auf Anfrage; Diffusorscheibe in Lieferung enthalten; DALI-Varianten für den Einsatz in Notbeleuchtungsanlagen auf Anfrage  
LED exchangeable, shade tool-free mountable; 110 V versions on request; diffuser included in delivery; DALI versions for the use in emergency lighting systems on request









CURLING ist ein modularer Artikel. Bitte jeweils Leuchteneinheit und Glasschirm zusammen bestellen.  
CURLING is a modular article. Please order the lighting unit and glass shade together.

☞ → 34–39    CURLING Suspension → 62 | CURLING Wall → 108

## CURLING Ceiling S





Abbildung figure	Beschreibung description	Leuchtmittel lamp	Regelung control	Leistung power	CCT	Lumen lumen	Art.-Nr. art.-no.	€ netto DE excl. VAT	€ brutto DE incl. VAT		
	<b>Leuchteneinheit S</b> lighting unit S	LED	TRIAC	11 W	2700 K	1130 lm	LE015701	180,67 €	215,00 €		
					3000 K	1180 lm	LE015702	180,67 €	215,00 €		
					1800–3000 K D2W	870 lm	LE015703	214,29 €	255,00 €		
					DALI	11 W	2700 K	1130 lm	LE015730	205,88 €	245,00 €
							3000 K	1180 lm	LE015731	205,88 €	245,00 €
							1800–3000 K D2W	870 lm	LE015732	239,50 €	285,00 €
	<b>Glas S klar</b> glass S clear					CU014406	180,67 €	215,00 €			
	<b>Glas S klar, Reflektor konisch</b> glass S clear, reflector conical					CU014407	201,68 €	240,00 €			
	<b>Glas S klar, Reflektor zylindrisch</b> glass S clear, reflector cylindrical					CU014408	201,68 €	240,00 €			
	<b>Glas S opal</b> glass S opal					CU014405	172,27 €	205,00 €			
	<b>Glas S neusilber</b> glass S new silver					CU011201	256,30 €	305,00 €			
	<b>Acrylglas S klar</b> acrylic glass S clear					CU011203	75,63 €	90,00 €			
	<b>Acrylglas S klar, Reflektor konisch</b> acrylic glass S clear, reflector conical					CU011204	92,44 €	110,00 €			
	<b>Acrylglas S klar, Reflektor zylindrisch</b> acrylic glass S clear, reflector cylindrical					CU011205	92,44 €	110,00 €			

## CURLING Ceiling M

Abbildung figure	Beschreibung description	Leuchtmittel lamp	Regelung control	Leistung power	CCT	Lumen lumen	Art.-Nr. art.-no.	€ netto DE excl. VAT	€ brutto DE incl. VAT		
	<b>Leuchteneinheit M</b> lighting unit M	LED	TRIAC	20 W	2700 K	1910 lm	LE015710	239,50 €	285,00 €		
					3000 K	2010 lm	LE015711	239,50 €	285,00 €		
					1800–3000 K D2W	1540 lm	LE015712	273,11 €	325,00 €		
					DALI 1–10 V	20 W	2700 K	1910 lm	LE015713	264,71 €	315,00 €
							3000 K	2010 lm	LE015714	264,71 €	315,00 €
							1800–3000 K D2W	1540 lm	LE015715	298,32 €	355,00 €
	<b>Glas M klar</b> glass M clear					CU014402	226,89 €	270,00 €			
	<b>Glas M klar, Reflektor konisch</b> glass M clear, reflector conical					CU014403	252,10 €	300,00 €			
	<b>Glas M klar, Reflektor zylindrisch</b> glass M clear, reflector cylindrical					CU014404	252,10 €	300,00 €			
	<b>Glas M opal</b> glass M opal					CU014401	214,29 €	255,00 €			
	<b>Glas M neusilber</b> glass M new silver					CU011202	323,53 €	385,00 €			
	<b>Acrylglas M klar</b> acrylic glass M clear					CU011206	100,84 €	120,00 €			
	<b>Acrylglas M klar, Reflektor konisch</b> acrylic glass M clear, reflector conical					CU011207	126,05 €	150,00 €			
	<b>Acrylglas M klar, Reflektor zylindrisch</b> acrylic glass M clear, reflector cylindrical					CU011208	126,05 €	150,00 €			



## CURLING Ceiling L

Abbildung figure	Beschreibung description	Leuchtmittel lamp	Regelung control	Leistung power	CCT	Lumen lumen	Art.-Nr. art.-no.	€ netto DE excl. VAT	€ brutto DE incl. VAT
	<b>Leuchteneinheit L</b> lighting unit L	LED	TRIAC	34 W	2700 K	3360 lm	LE014480	289,92 €	345,00 €
					3000 K	3480 lm	LE014483	289,92 €	345,00 €
			DALI	34 W	2700 K	3360 lm	LE014478	315,13 €	375,00 €
					3000 K	3480 lm	LE014481	315,13 €	375,00 €
	<b>Glas L klar</b> glass L clear						CU014475	310,92 €	370,00 €
	<b>Glas L klar, Reflektor konisch</b> glass L clear, reflector conical						CU014476	344,54 €	410,00 €
	<b>Glas L klar, Reflektor zylindrisch</b> glass L clear, reflector cylindrical						CU014477	344,54 €	410,00 €
	<b>Glas L neusilber</b> glass L new silver						CU014478	399,16 €	475,00 €

## CURLING Ceiling – Zubehör / Accessories

<b>Optiken</b> optics	<b>Einfach austauschbare Optiken zur Bestimmung der Lichtverteilung von CURLING Ceiling finden Sie auf Seite 201.</b> Easily replaceable optics to define the light distribution of CURLING Ceiling, see page 201.
--------------------------	---

## REEF Ceiling

Die unverwechselbaren Leuchtschirme dieser Familie bestehen aus innovativer Schaumkeramik, deren Struktur stark an Korallen erinnert. Dabei sind sie durabel, spülmaschinentauglich und verteilen das Streulicht perfekt in einem sanften Bone China-Farbtönen. Die zylindrischen Körper sind einseitig offen – so strahlen die Leuchten dieser Familie kräftig und brillant, aber völlig blendfrei.

The unmistakable lamp shades in this family are made of innovative foam ceramic, whose texture is highly reminiscent of corals. That said they are durable, dishwasher-proof and distribute the scattered light perfectly in a gentle bone china hue. The cylindrical objects are open on one side, such that the lamps in this family shine powerfully and brightly, though without any glare at all.



reddot design award  
winner 2004

DESIGN PLUS

Focus Balance  
Silber

Internationaler Designpreis  
Baden-Württemberg 2003

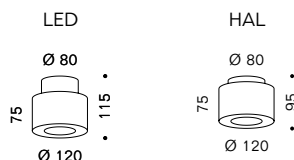

<b>Licht</b> light	<b>nach unten gerichtet, rundum diffus</b> directed downwards, diffuse all around
<b>Leuchtmittel</b> lamp	LED 8 W, CoB, CRI Ra>97 (R9>80), EEK/EEC F G9 max. 33 W, EEK/EEC G
<b>Gehäuse</b> Housing	<b>Aluminium poliert oder gebürstet; Schirm: Keramikschaum weiß</b> aluminium polished or brushed; shade: ceramic foam white
<b>Sonstiges</b> features	<b>LED austauschbar, Schirm werkzeuglos abnehmbar und spülmaschinenfest</b> LED exchangeable, shade tool-free removable and dishwasher safe

## REEF Ceiling

Abbildung figure	Beschreibung description	Leuchtmittel lamp	Regelung control	Leistung power	CCT	Lumen lumen	Art.-Nr. art.-no.	€ netto DE excl. VAT	€ brutto DE incl. VAT
●	<b>gebürstet</b> brushed	LED	TRIAC	8 W	2700 K	790 lm	RF2007	336,13 €	400,00 €
		G9	TRIAC	max. 33 W	2700 K	460 lm	RF1012	210,08 €	250,00 €
●	<b>poliert</b> polished	LED	TRIAC	8 W	2700 K	790 lm	RF2009	344,54 €	410,00 €
		G9	TRIAC	max. 33 W	2700 K	460 lm	RF1017	218,49 €	260,00 €

## DRAFT Ceiling

**DRAFT Ceiling macht aus der archetypischen Kugelleuchte ein Objekt von zeitgenössischer Prägnanz und perfekt ausbalancierter Lichtwirkung. Die transparente, mundgeblasene Glaskugel und der lichtdurchlässige, mattweiße Innenreflektor treten in einen spannenden Kontrast. Das LED-Leuchtmittel tief im Inneren des konischen Reflektors sorgt rundum für weich gestreutes Raumlicht und gerichtetes Licht nach unten. Eine Diffusorscheibe gewährleistet einen besonders weichen Lichtaustritt und gleichmäßig beleuchtete Flächen. DRAFT ist absolut blendfrei, verfügt über zwei verschiedene Lichtfarben und die Dim2warm-Funktion.**

DRAFT turns the archetypical spherical luminaire into an object that boasts an unpretentious contemporary look and perfectly balanced light. The transparent, hand-blown glass ball and the translucent, matte white internal reflector make for a striking contrast. Set deep in the internal reflector, the LED illuminant delivers softly diffused all-round and downward directional light. A diffuser plate ensures particularly soft light and evenly illuminated spaces. DRAFT is absolutely glare-free, comes with two different light colors and the Dim2warm function.

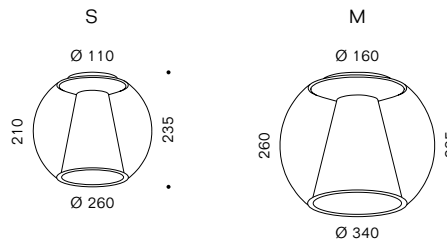

---

<b>Leuchtmittel</b> lamp	LED 11–20 W, CoB, CRI Ra>90 (R9>80), EEK/EEC F (2700 K, 3000 K), G (1800–3000 K D2W)
-----------------------------	--

---

<b>Baldachin</b> canopy	<b>Aluminium hochglanzpoliert</b> aluminum highly polished
----------------------------	---

---

<b>Schirm</b> shade	<b>mundgeblasenes Glas klar, Reflektor Acrylglas opal</b> hand-blown glass clear; reflector acrylic glass opal
------------------------	---

---

<b>Ausführungen</b> versions	<b>Glasschirm klar, braun oder blau, Reflektor konisch opal; Licht: nach unten gerichtet, rundum weich gestreut</b> glass shade clear, brown or blue reflector conical; light: directed downwards, diffused all around
---------------------------------	---







---

<b>Sonstiges</b> features	<b>LED wechselbar, werkzeuglose Schirmmontage; 110 V-Varianten auf Anfrage; DALI-Varianten für den Einsatz in Notbeleuchtungsanlagen auf Anfrage</b> LED exchangeable, shade tool-free mountable; 110 V versions on request; DALI versions for the use in emergency lighting systems on request
------------------------------	--



---

**DRAFT ist ein modularer Artikel. Bitte jeweils Leuchteneinheit und Glasschirm zusammen bestellen.**  
DRAFT is a modular article. Please order the lighting unit and glass shade together.

## DRAFT Ceiling S

Abbildung figure	Beschreibung description	Leuchtmittel lamp	Regelung control	Leistung power	CCT	Lumen lumen	Art.-Nr. art.-no.	€ netto DE excl. VAT	€ brutto DE incl. VAT
	<b>Leuchteneinheit S</b> lighting unit S	LED	TRIAC	11 W	2700 K	1130 lm	LE015701	180,67 €	215,00 €
					3000 K	1180 lm	LE015702	180,67 €	215,00 €
					1800–3000 K D2W	870 lm	LE015703	214,29 €	255,00 €
			DALI	11 W	2700 K	1130 lm	LE015730	205,88 €	245,00 €
					3000 K	1180 lm	LE015731	205,88 €	245,00 €
					1800–3000 K D2W	870 lm	LE015732	239,50 €	285,00 €
	<b>Glas S klar mit Reflektor</b> glass S clear with reflector						DR015728	247,90 €	295,00 €
	<b>Glas S braun mit Reflektor</b> glass S brown with reflector						DR015729	285,71 €	340,00 €
	<b>Glas S blau mit Reflektor</b> glass S blue with reflector						DR015730	285,71 €	340,00 €

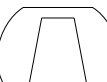
## DRAFT Ceiling M

Abbildung figure	Beschreibung description	Leuchtmittel lamp	Regelung control	Leistung power	CCT	Lumen lumen	Art.-Nr. art.-no.	€ netto DE excl. VAT	€ brutto DE incl. VAT
	<b>Leuchteneinheit M</b> lighting unit M	LED	TRIAC	20 W	2700 K	1910 lm	LE015710	239,50 €	285,00 €
					3000 K	2010 lm	LE015711	239,50 €	285,00 €
					1800–3000 K D2W	1540 lm	LE015712	273,11 €	325,00 €
			DALI 1–10 V	20 W	2700 K	1910 lm	LE015713	264,71 €	315,00 €
					3000 K	2010 lm	LE015714	264,71 €	315,00 €
					1800–3000 K D2W	1540 lm	LE015715	298,32 €	355,00 €
	<b>Glas M klar mit Reflektor</b> glass M clear with reflector						DR015731	327,73 €	390,00 €
	<b>Glas M braun mit Reflektor</b> glass M brown with reflector						DR015732	373,95 €	445,00 €
	<b>Glas M blau mit Reflektor</b> glass M blue with reflector						DR015733	373,95 €	445,00 €

## DRUM Ceiling

Mit ihrer zylindrischen Form passt DRUM Ceiling besonders gut zu geradliniger Architektur, in den Objektbereich oder in Privaträume. Die Kegelform des opalen Innenreflektors ist jeweils abhängig von Höhe und Durchmesser der transparenten Außenform aus Glas. In der jeweiligen Kombination entsteht so ein geometrisches Spiel von klaren Zylindern und Kegeln mit verschiedenen Winkeln im Inneren. DRUM Ceiling sorgt absolut blendfrei für mildes Raumlicht und gerichtetes Licht nach unten.

With its cylindrical shape DRUM Ceiling fits perfectly into clean-cut architecture, the contract world, or private spaces. The conical shape of the opaline internal reflector depends on the height and diameter of the transparent outer body made of glass. The respective combination gives rise to a geometric interplay of clear cylinders and cones with different angles on the inside. DRUM Ceiling provides absolutely glare-free mild ambient light and light that is directed carefully downwards.

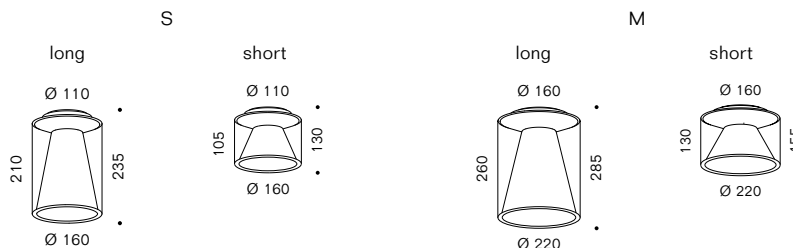

**Licht**  
light **nach unten gerichtet, rundum weich gestreut**  
directed downwards, diffused all around

**Leuchtmittel**  
lamp LED 11–20 W, CoB, CRI Ra>90 (R9>80), EEK/EEC F (2700 K, 3000 K), G (1800–3000 K D2W)

**Leuchteneinheit**  
lighting unit **Aluminium hochglanzpoliert**  
aluminum highly polished

**Glasschirm**  
glass shade **mundgeblasenes Glas klar, Reflektor Acrylglas opal**  
hand-blown glass clear; reflector acrylic glass opal



**Ausführungen**  
versions





**Sonstiges**  
features **LED wechselbar, werkzeuglose Schirmmontage; 110 V-Varianten auf Anfrage;**  
**DALI-Varianten für den Einsatz in Notbeleuchtungsanlagen auf Anfrage**  
LED exchangeable, shade tool-free mountable; 110 V versions on request;  
DALI versions for the use in emergency lighting systems on request

**DRUM ist ein modularer Artikel. Bitte jeweils Leuchteneinheit und Glasschirm zusammen bestellen.**  
DRUM is a modular article. Please order the lighting unit and glass shade together.

## DRUM Ceiling S

Abbildung figure	Beschreibung description	Leuchtmittel lamp	Regelung control	Leistung power	CCT	Lumen lumen	Art.-Nr. art.-no.	€ netto DE excl. VAT	€ brutto DE incl. VAT
	<b>Leuchteneinheit S</b> lighting unit S	LED	TRIAC	11 W	2700 K	1130 lm	LE015701	180,67 €	215,00 €
					3000 K	1180 lm	LE015702	180,67 €	215,00 €
					1800–3000 K D2W	870 lm	LE015703	214,29 €	255,00 €
			DALI	11 W	2700 K	1130 lm	LE015730	205,88 €	245,00 €
					3000 K	1180 lm	LE015731	205,88 €	245,00 €
					1800–3000 K D2W	870 lm	LE015732	239,50 €	285,00 €
	<b>Glas S long mit Reflektor</b> glass S long with reflector						DU015801	189,08 €	225,00 €
	<b>Glas S short mit Reflektor</b> glass S short with reflector						DU015802	142,86 €	170,00 €

## DRUM Ceiling M

Abbildung figure	Beschreibung description	Leuchtmittel lamp	Regelung control	Leistung power	CCT	Lumen lumen	Art.-Nr. art.-no.	€ netto DE excl. VAT	€ brutto DE incl. VAT
	<b>Leuchteneinheit M</b> lighting unit M	LED	TRIAC	20 W	2700 K	1910 lm	LE015710	239,50 €	285,00 €
					3000 K	2010 lm	LE015711	239,50 €	285,00 €
					1800–3000 K D2W	1540 lm	LE015712	273,11 €	325,00 €
			DALI 1–10 V	20 W	2700 K	1910 lm	LE015713	264,71 €	315,00 €
					3000 K	2010 lm	LE015714	264,71 €	315,00 €
					1800–3000 K D2W	1540 lm	LE015715	298,32 €	355,00 €
	<b>Glas M long mit Reflektor</b> glass M long with reflector						DU015803	222,69 €	265,00 €
	<b>Glas M short mit Reflektor</b> glass M short with reflector						DU015804	172,27 €	205,00 €



## POPPY Ceiling

Werden die „Mohnblüten“ dieser Familie durch Einschalten geweckt, öffnen sich ihre Schirme ganz allmählich: die feinen Blätter sind aus Bimetall und dehnen sich durch Erwärmung aus. Alle Varianten können nach Belieben umgestaltet werden. Der flexible, textilmantelte Schlauch lässt sich immer neu biegen – zur Änderung der Lichtrichtung oder einfach weil Ihnen danach ist. Die mundgeblasenen Glaskapseln sind erhältlich den Farben keramik, rubinrot oder violett.

When the “poppy flowers” in this family are woken by the lamp being switched on, their shades open very gradually: the delicate leaves are bi-metallic and expand when heated. All the versions can be reshaped as desired. The flexible, textile-coated stem can be bent at will, to change the direction of the light, or because you just feel like it. The hand-blown glass capsules are available in ceramic, ruby red or violet.

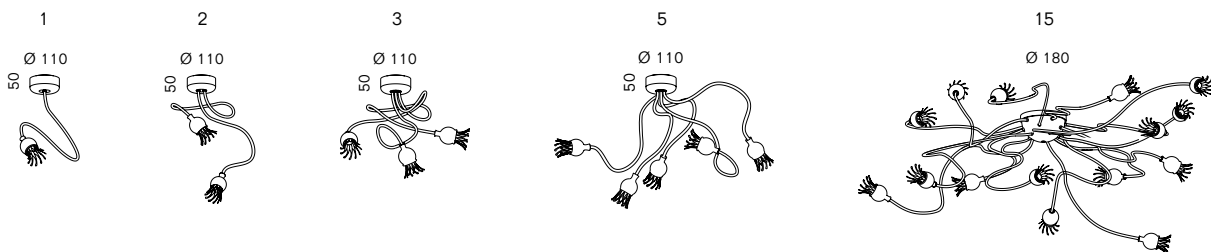

**Licht**  
light **nach vorne gerichtet, rundum dekorativ**  
directed forward, decorative all around

**Leuchtmittel**  
lamp **POPPY Ceiling 1/2/3: 1 x/2 x/3 x G4 35 W, 12 V, EEK/EEC G**  
**POPPY Ceiling 5/15: 5 x/15 x G4 20 W, 12 V, EEK/EEC G**

**Größen**  
sizes **1 bis 5 Arme: Länge der Arme 75 cm, 15 Arme: Länge der Arme 75 oder 150 cm**  
1 to 5 arms: length of arms 75 cm, 15 arms: length of arms 75 cm or 150 cm







**Material**  
material **Arme, flexibel: Aluminium, textilmantelt beige oder schwarz; Glasschirme: mundgeblasenes Glas in keramik, rubinrot oder violett; Lamellen: Bimetall; Baldachin: 1–5 Arme Edelstahl, poliert; 15 Arme: Edelstahl gebürstet**  
arms, flexible: textile coated aluminium tube in beige or black; glass shade: hand-blown glass in ceramic, ruby red or violet  
lamellae: bimetal; canopy: 1–5 arms stainless steel, polished; 15 arms: stainless steel, brushed

**Sonstiges**  
features **Leuchtmittel in Lieferung enthalten; Reflektor-Lamellen öffnen sich nach ca. 2 Minuten Betriebszeit; Leuchte kann auch als Wandleuchte montiert werden**  
lamps included in delivery; lamellae open within approx. 2 minutes after switching on luminaire; luminaire can also be mounted as wall luminaire







## POPPY Ceiling 1

Abbildung figure	Beschreibung description	Fassung socket	Regelung control	Leistung power	Art.-Nr. art.-no.	€ netto DE excl. VAT	€ brutto DE incl. VAT
	<b>1 Arm schwarz, Schirm keramik</b> 1 arm black, shade ceramic	G4	ON/OFF	max. 35 W	PO1025	394,96 €	470,00 €
	<b>1 Arm schwarz, Schirm rubinrot</b> 1 arm black, shade ruby red	G4	ON/OFF	max. 35 W	PO1026	394,96 €	470,00 €
	<b>1 Arm schwarz, Schirm violett</b> 1 arm black, shade violet	G4	ON/OFF	max. 35 W	PO1027	394,96 €	470,00 €
	<b>1 Arm beige, Schirm keramik</b> 1 arm beige shade ceramic	G4	ON/OFF	max. 35 W	PO1028	394,96 €	470,00 €
	<b>1 Arm beige, Schirm rubinrot</b> 1 arm beige shade ruby red	G4	ON/OFF	max. 35 W	PO1029	394,96 €	470,00 €
	<b>1 Arm beige, Schirm violett</b> 1 arm beige shade violet	G4	ON/OFF	max. 35 W	PO1030	394,96 €	470,00 €







## POPPY Ceiling 2

Abbildung figure	Beschreibung description	Fassung socket	Regelung control	Leistung power	Art.-Nr. art.-no.	€ netto DE excl. VAT	€ brutto DE incl. VAT
	<b>2 Arme schwarz, Schirme keramik</b> 2 arms black, shades ceramic	2 × G4	ON/OFF	max. 70 W	PO1031	495,80 €	590,00 €
	<b>2 Arme schwarz, Schirme rubinrot</b> 2 arms black, shades ruby red	2 × G4	ON/OFF	max. 70 W	PO1032	495,80 €	590,00 €
	<b>2 Arme schwarz, Schirme violett</b> 2 arms black, shades violet	2 × G4	ON/OFF	max. 70 W	PO1033	495,80 €	590,00 €
	<b>2 Arme beige, Schirme keramik</b> 2 arms beige shades ceramic	2 × G4	ON/OFF	max. 70 W	PO1034	495,80 €	590,00 €
	<b>2 Arme beige, Schirme rubinrot</b> 2 arms beige shades ruby red	2 × G4	ON/OFF	max. 70 W	PO1035	495,80 €	590,00 €
	<b>2 Arme beige, Schirme violett</b> 2 arms beige shades violet	2 × G4	ON/OFF	max. 70 W	PO1036	495,80 €	590,00 €







## POPPY Ceiling 3

Abbildung figure	Beschreibung description	Fassung socket	Regelung control	Leistung power	Art.-Nr. art.-no.	€ netto DE excl. VAT	€ brutto DE incl. VAT
	<b>3 Arme schwarz, Schirme keramik</b> 3 arms black, shades ceramic	3 × G4	ON/OFF	max. 105 W	PO1037	596,64 €	710,00 €
	<b>3 Arme schwarz, Schirme rubinrot</b> 3 arms black, shades ruby red	3 × G4	ON/OFF	max. 105 W	PO1038	596,64 €	710,00 €
	<b>3 Arme schwarz, Schirme violett</b> 3 arms black, shades violet	3 × G4	ON/OFF	max. 105 W	PO1039	596,64 €	710,00 €
	<b>3 Arme beige, Schirme keramik</b> 3 arms beige shades ceramic	3 × G4	ON/OFF	max. 105 W	PO1040	596,64 €	710,00 €
	<b>3 Arme beige, Schirme rubinrot</b> 3 arms beige shades ruby red	3 × G4	ON/OFF	max. 105 W	PO1041	596,64 €	710,00 €
	<b>3 Arme beige, Schirme violett</b> 3 arms beige shades violet	3 × G4	ON/OFF	max. 105 W	PO1042	596,64 €	710,00 €

## POPPY Ceiling 5

Abbildung figure	Beschreibung description	Fassung socket	Regelung control	Leistung power	Art.-Nr. art.-no.	€ netto DE excl. VAT	€ brutto DE incl. VAT
	<b>5 Arme schwarz, Schirme keramik</b> 5 arms black, shades ceramic	5 × G4	ON/OFF	max. 100 W	PO1043	773,11 €	920,00 €
	<b>5 Arme schwarz, Schirme rubinrot</b> 5 arms black, shades ruby red	5 × G4	ON/OFF	max. 100 W	PO1044	773,11 €	920,00 €
	<b>5 Arme schwarz, Schirme violett</b> 5 arms black, shades violet	5 × G4	ON/OFF	max. 100 W	PO1045	773,11 €	920,00 €
	<b>5 Arme beige, Schirme keramik</b> 5 arms beige shades ceramic	5 × G4	ON/OFF	max. 100 W	PO1046	773,11 €	920,00 €
	<b>5 Arme beige, Schirme rubinrot</b> 5 arms beige shades ruby red	5 × G4	ON/OFF	max. 100 W	PO1047	773,11 €	920,00 €
	<b>5 Arme beige, Schirme violett</b> 5 arms beige shades violet	5 × G4	ON/OFF	max. 100 W	PO1048	773,11 €	920,00 €

## POPPY Ceiling 15

Abbildung figure	Beschreibung description	Fassung socket	Regelung control	Leistung power	Art.-Nr. art.-no.	€ netto DE excl. VAT	€ brutto DE incl. VAT
	<b>15 Arme 75 cm schwarz, Schirme keramik</b> 15 arms 75 cm black, shades ceramic	15 x G4	ON/OFF	max. 300 W	PO1007	1.764,71 €	2.100,00 €
	<b>15 Arme 150 cm schwarz, Schirme keramik</b> 15 arms 150 cm black, shades ceramic	15 x G4	ON/OFF	max. 300 W	PO1010	1.848,74 €	2.200,00 €
	<b>15 Arme 75 cm schwarz, Schirme rubinrot</b> 15 arms 75 cm black, shades ruby red	15 x G4	ON/OFF	max. 300 W	PO1008	1.764,71 €	2.100,00 €
	<b>15 Arme 150 cm schwarz, Schirme rubinrot</b> 15 arms 150 cm black, shades ruby red	15 x G4	ON/OFF	max. 300 W	PO1011	1.848,74 €	2.200,00 €
	<b>15 Arme 75 cm schwarz, Schirme violett</b> 15 arms 75 cm black, shades violet	15 x G4	ON/OFF	max. 300 W	PO1009	1.764,71 €	2.100,00 €
	<b>15 Arme 150 cm schwarz, Schirme violett</b> 15 arms 150 cm black, shades violet	15 x G4	ON/OFF	max. 300 W	PO1012	1.848,74 €	2.200,00 €
	<b>15 Arme 75 cm beige, Schirme keramik</b> 15 arms 75 cm beige, shades ceramic	15 x G4	ON/OFF	max. 300 W	PO1013	1.764,71 €	2.100,00 €
	<b>15 Arme 150 cm beige, Schirme keramik</b> 15 arms 150 cm beige, shades ceramic	15 x G4	ON/OFF	max. 300 W	PO1016	1.848,74 €	2.200,00 €
	<b>15 Arme 75 cm beige, Schirme rubinrot</b> 15 arms 75 cm beige, shades ruby red	15 x G4	ON/OFF	max. 300 W	PO1014	1.764,71 €	2.100,00 €
	<b>15 Arme 150 cm beige, Schirme rubinrot</b> 15 arms 150 cm beige, shades ruby red	15 x G4	ON/OFF	max. 300 W	PO1017	1.848,74 €	2.200,00 €
	<b>15 Arme 75 cm beige, Schirme violett</b> 15 arms 75 cm beige, shades violet	15 x G4	ON/OFF	max. 300 W	PO1015	1.764,71 €	2.100,00 €
	<b>15 Arme 150 cm beige, Schirme violett</b> 15 arms 150 cm beige, shades violet	15 x G4	ON/OFF	max. 300 W	PO1018	1.848,74 €	2.200,00 €

## REFLEX<sup>2</sup> Ceiling

Bei REFLEX<sup>2</sup> sorgt das auf einen eigenen Deckenreflektor strahlende Licht für eine überzeugende Lichtlösung am zentralen Deckenanschluss im Raum. REFLEX<sup>2</sup> besitzt eine feine, elegant abgerundete Rahmenstruktur, die LED-Platinen enthält. Sie strahlen auf eine Reflektorfläche im gleichen Grundmaß. REFLEX<sup>2</sup> bietet auch bei voller Leistung ein absolut blendfreies Licht, das optional per Bluetooth gesteuert werden kann. Aus einer dezenten Struktur entstehen so intensive Lichtstimmungen im Raum.

REFLEX<sup>2</sup> presents a convincing lighting solution at the central ceiling connection in a space by employing a special ceiling reflector. REFLEX<sup>2</sup> has delicate, elegantly rounded frame structure that contains the LED boards. Their light hits a reflector surface of the same basic dimensions. Even at full power, REFLEX<sup>2</sup> creates an absolutely glare-free light, whose color may further be adjusted optional via Bluetooth. As such, the subtle structure gives rise to intensive lighting moods in the space.

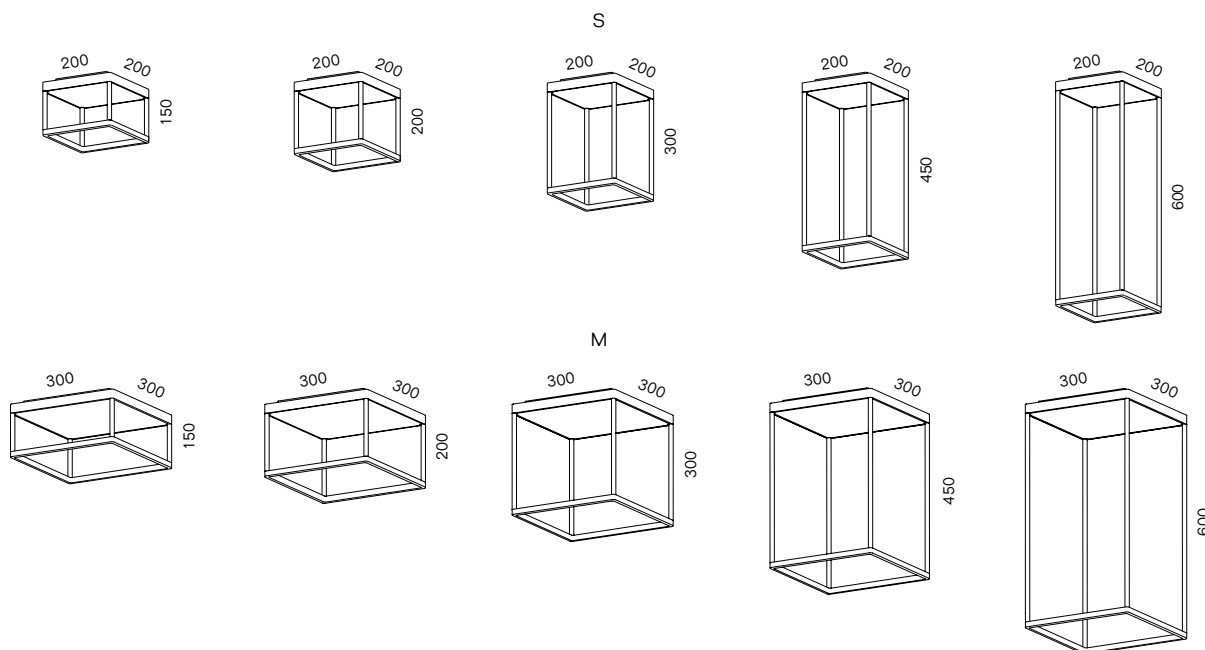

**Licht**  
light **nach oben gestreut, indirekt über Deckenreflektor und Decke**  
scattered upwards, diffuse all around due to reflector and ceiling

**Leuchtmittel**  
lamp **LED 33–50 W, CRI Ra>90 (R9>50), EEK/EEC E**  
S: 2700 K, 3000 K oder/or Dim2Warm, M: 2700 K, 3000 K oder/or 2200–4000 K/tunable white

**Gehäuse**  
housing **Aluminium schwarz oder weiß beschichtet**  
aluminium black or white coated

**Material**  
material **Reflektor: PLEXIGLAS® Pyramidenstruktur oder PLEXIGLAS® matt; Leuchtmittelabdeckungen: Flachglas satinée**  
reflector: PLEXIGLAS® pyramid structure or PLEXIGLAS® matte; lamp cover: glass semigloss

**Sonstiges**  
features **+C kennzeichnet Produkte mit vorprogrammiertem CASAMBI-Modul in der Leuchte integriert. LED austauschbar; Einfache Montage; Reflektor einfach wechselbar; 110 V-Varianten auf Anfrage**  
+C indicates products with pre-programmed CASAMBI module integrated in the luminaire.  
LED exchangeable; easy assembly; reflector easily exchangeable; 110 V versions on request

**REFLEX<sup>2</sup> ist ein modularer Artikel. Bitte jeweils Leuchteneinheit und Reflektor zusammen bestellen.**  
REFLEX<sup>2</sup> is a modular article. Please order the lamp unit and reflector together.

# REFLEX<sup>2</sup> Ceiling S

Abbildung figure	Beschreibung description	Leuchtmittel lamp	Regelung control	Leistung power	CCT	Lumen lumen	Art.-Nr. art.-no.	€ netto DE excl. VAT	€ brutto DE incl. VAT
●	150 schwarz 150 black	LED	TRIAC	33 W	2700 K	3910 lm	RE2450	344,54 €	410,00 €
					3000 K	3960 lm	RE2451	344,54 €	410,00 €
					2200–3000 K D2W	3910 lm	RE2401	382,35 €	455,00 €
			DALI	33 W	2700 K	3910 lm	RE2460	386,55 €	460,00 €
					3000 K	3960 lm	RE2461	386,55 €	460,00 €
					2200–3000 K D2W	3910 lm	RE2402	424,37 €	505,00 €
					2200–3000 K D2W + C	3910 lm	RE2402C	537,82 €	640,00 €
					2700 K	3910 lm	RE2452	344,54 €	410,00 €
					3000 K	3960 lm	RE2453	344,54 €	410,00 €
○	150 weiß 150 white	LED	TRIAC	33 W	2700 K	3910 lm	RE2452	344,54 €	410,00 €
					3000 K	3960 lm	RE2453	344,54 €	410,00 €
					2200–3000 K D2W	3910 lm	RE2403	382,35 €	455,00 €
			DALI	33 W	2700 K	3910 lm	RE2462	386,55 €	460,00 €
					3000 K	3960 lm	RE2463	386,55 €	460,00 €
					2200–3000 K D2W	3910 lm	RE2404	424,37 €	505,00 €
					2200–3000 K D2W + C	3910 lm	RE2404C	537,82 €	640,00 €
					2700 K	3910 lm	RE2550	344,54 €	410,00 €
					3000 K	3960 lm	RE2551	344,54 €	410,00 €
●	200 schwarz 200 black	LED	TRIAC	33 W	2700 K	3910 lm	RE2550	344,54 €	410,00 €
					3000 K	3960 lm	RE2551	344,54 €	410,00 €
					2200–3000 K D2W	3910 lm	RE2501	382,35 €	455,00 €
			DALI	33 W	2700 K	3910 lm	RE2560	386,55 €	460,00 €
					3000 K	3960 lm	RE2561	386,55 €	460,00 €
					2200–3000 K D2W	3910 lm	RE2502	424,37 €	505,00 €
					2200–3000 K D2W + C	3910 lm	RE2502C	537,82 €	640,00 €
					2700 K	3910 lm	RE2552	344,54 €	410,00 €
					3000 K	3960 lm	RE2553	344,54 €	410,00 €
○	200 weiß 200 white	LED	TRIAC	33 W	2700 K	3910 lm	RE2552	344,54 €	410,00 €
					3000 K	3960 lm	RE2553	344,54 €	410,00 €
					2200–3000 K D2W	3910 lm	RE2503	382,35 €	455,00 €
			DALI	33 W	2700 K	3910 lm	RE2562	386,55 €	460,00 €
					3000 K	3960 lm	RE2563	386,55 €	460,00 €
					2200–3000 K D2W	3910 lm	RE2504	424,37 €	505,00 €
					2200–3000 K D2W + C	3910 lm	RE2504C	537,82 €	640,00 €
					2700 K	3910 lm	RE2650	344,54 €	410,00 €
					3000 K	3960 lm	RE2651	344,54 €	410,00 €
●	300 schwarz 300 black	LED	TRIAC	33 W	2700 K	3910 lm	RE2650	344,54 €	410,00 €
					3000 K	3960 lm	RE2651	344,54 €	410,00 €
					2200–3000 K D2W	3910 lm	RE2601	382,35 €	455,00 €
			DALI	33 W	2700 K	3910 lm	RE2660	386,55 €	460,00 €
					3000 K	3960 lm	RE2661	386,55 €	460,00 €
					2200–3000 K D2W	3910 lm	RE2602	424,37 €	505,00 €
					2200–3000 K D2W + C	3910 lm	RE2602C	537,82 €	640,00 €
					2700 K	3910 lm	RE2652	344,54 €	410,00 €
					3000 K	3960 lm	RE2653	344,54 €	410,00 €
○	300 weiß 300 white	LED	TRIAC	33 W	2700 K	3910 lm	RE2652	344,54 €	410,00 €
					3000 K	3960 lm	RE2653	344,54 €	410,00 €
					2200–3000 K D2W	3910 lm	RE2603	382,35 €	455,00 €
			DALI	33 W	2700 K	3910 lm	RE2662	386,55 €	460,00 €
					3000 K	3960 lm	RE2663	386,55 €	460,00 €
					2200–3000 K D2W	3910 lm	RE2604	424,37 €	505,00 €
					2200–3000 K D2W + C	3910 lm	RE2604C	537,82 €	640,00 €

## REFLEX<sup>2</sup> Ceiling S

Abbildung figure	Beschreibung description	Leuchtmittel lamp	Regelung control	Leistung power	CCT	Lumen lumen	Art.-Nr. art.-no.	€ netto DE excl. VAT	€ brutto DE incl. VAT
●	<b>450 schwarz</b> 450 black	LED	TRIAC	33 W	2700 K	3910 lm	RE2750	344,54 €	410,00 €
					3000 K	3960 lm	RE2751	344,54 €	410,00 €
					2200–3000 K D2W	3910 lm	RE2701	382,35 €	455,00 €
			DALI	33 W	2700 K	3910 lm	RE2760	386,55 €	460,00 €
					3000 K	3960 lm	RE2761	386,55 €	460,00 €
					2200–3000 K D2W	3910 lm	RE2702	424,37 €	505,00 €
					2200–3000 K D2W + C	3910 lm	RE2702C	537,82 €	640,00 €
					2700 K	3910 lm	RE2752	344,54 €	410,00 €
					3000 K	3960 lm	RE2753	344,54 €	410,00 €
○	<b>450 weiß</b> 450 white	LED	TRIAC	33 W	2700 K	3910 lm	RE2703	382,35 €	455,00 €
					2700 K	3910 lm	RE2762	386,55 €	460,00 €
					3000 K	3960 lm	RE2763	386,55 €	460,00 €
			DALI	33 W	2200–3000 K D2W	3910 lm	RE2704	424,37 €	505,00 €
					2200–3000 K D2W + C	3910 lm	RE2704C	537,82 €	640,00 €
					2700 K	3910 lm	RE2950	344,54 €	410,00 €
					3000 K	3960 lm	RE2951	344,54 €	410,00 €
					2200–3000 K D2W	3910 lm	RE2901	382,35 €	455,00 €
					2700 K	3910 lm	RE2960	386,55 €	460,00 €
●	<b>600 schwarz</b> 600 black	LED	DALI	33 W	3000 K	3960 lm	RE2961	386,55 €	460,00 €
					2200–3000 K D2W	3910 lm	RE2902	424,37 €	505,00 €
					2200–3000 K D2W + C	3910 lm	RE2902C	537,82 €	640,00 €
			TRIAC	33 W	2700 K	3910 lm	RE2952	344,54 €	410,00 €
					3000 K	3960 lm	RE2953	344,54 €	410,00 €
					2200–3000 K D2W	3910 lm	RE2903	382,35 €	455,00 €
					2700 K	3910 lm	RE2962	386,55 €	460,00 €
					3000 K	3960 lm	RE2963	386,55 €	460,00 €
					2200–3000 K D2W	3910 lm	RE2904	424,37 €	505,00 €
○	<b>600 weiß</b> 600 white	LED	DALI	33 W	2200–3000 K D2W + C	3910 lm	RE2904C	537,82 €	640,00 €
					2700 K	3910 lm	RE2950	344,54 €	410,00 €
					3000 K	3960 lm	RE2951	344,54 €	410,00 €
					2200–3000 K D2W	3910 lm	RE2901	382,35 €	455,00 €
					2700 K	3910 lm	RE2962	386,55 €	460,00 €
					3000 K	3960 lm	RE2963	386,55 €	460,00 €

## REFLEX<sup>2</sup> Ceiling S Reflektor

Abbildung figure	Beschreibung description	Art.-Nr. art.-no.	€ netto DE excl. VAT	€ brutto DE incl. VAT
○	<b>Pyramidenstruktur weiß</b> pyramid structure white	RE3051	84,03 €	100,00 €
●	<b>Pyramidenstruktur silber</b> pyramid structure silver	RE3052	84,03 €	100,00 €
●	<b>Pyramidenstruktur gold</b> pyramid structure gold	RE3053	84,03 €	100,00 €
○	<b>matt weiß</b> matte white	RE3054	84,03 €	100,00 €



# REFLEX<sup>2</sup> Ceiling M

Abbildung figure	Beschreibung description	Leuchtmittel lamp	Regelung control	Leistung power	CCT	Lumen lumen	Art.-Nr. art.-no.	€ netto DE excl. VAT	€ brutto DE incl. VAT
●	150 schwarz 150 black	LED	TRIAC 0-10 V	40 W	2700 K	4900 lm	RE2001	525,21 €	625,00 €
					3000 K	5000 lm	RE2002	525,21 €	625,00 €
					2700 K	5700 lm	RE2003	571,43 €	680,00 €
			DALI	50 W	3000 K	5800 lm	RE2004	571,43 €	680,00 €
					2200-4000 K TW	6040 lm	RE2005	659,66 €	785,00 €
					2200-4000 K TW + C	6040 lm	RE2005C	785,71 €	935,00 €
○	150 weiß 150 white	LED	TRIAC 0-10 V	40 W	2700 K	4900 lm	RE2006	525,21 €	625,00 €
					3000 K	5000 lm	RE2007	525,21 €	625,00 €
					2700 K	5700 lm	RE2008	571,43 €	680,00 €
			DALI	50 W	3000 K	5800 lm	RE2009	571,43 €	680,00 €
					2200-4000 K TW	6040 lm	RE2010	659,66 €	785,00 €
					2200-4000 K TW + C	6040 lm	RE2010C	785,71 €	935,00 €
●	200 schwarz 200 black	LED	TRIAC 0-10 V	40 W	2700 K	4900 lm	RE2801	525,21 €	625,00 €
					3000 K	5000 lm	RE2802	525,21 €	625,00 €
					2700 K	5700 lm	RE2803	571,43 €	680,00 €
			DALI	50 W	3000 K	5800 lm	RE2804	571,43 €	680,00 €
					2200-4000 K TW	6040 lm	RE2805	659,66 €	785,00 €
					2200-4000 K TW + C	6040 lm	RE2805C	785,71 €	935,00 €
○	200 weiß 200 white	LED	TRIAC 0-10 V	40 W	2700 K	4900 lm	RE2806	525,21 €	625,00 €
					3000 K	5000 lm	RE2807	525,21 €	625,00 €
					2700 K	5700 lm	RE2808	571,43 €	680,00 €
			DALI	50 W	3000 K	5800 lm	RE2809	571,43 €	680,00 €
					2200-4000 K TW	6040 lm	RE2810	659,66 €	785,00 €
					2200-4000 K TW + C	6040 lm	RE2810C	785,71 €	935,00 €
●	300 schwarz 300 black	LED	TRIAC 0-10 V	40 W	2700 K	4900 lm	RE2101	525,21 €	625,00 €
					3000 K	5000 lm	RE2102	525,21 €	625,00 €
					2700 K	5700 lm	RE2103	571,43 €	680,00 €
			DALI	50 W	3000 K	5800 lm	RE2104	571,43 €	680,00 €
					2200-4000 K TW	6040 lm	RE2105	659,66 €	785,00 €
					2200-4000 K TW + C	6040 lm	RE2105C	785,71 €	935,00 €
○	300 weiß 300 white	LED	TRIAC 0-10 V	40 W	2700 K	4900 lm	RE2106	525,21 €	625,00 €
					3000 K	5000 lm	RE2107	525,21 €	625,00 €
					2700 K	5700 lm	RE2108	571,43 €	680,00 €
			DALI	50 W	3000 K	5800 lm	RE2109	571,43 €	680,00 €
					2200-4000 K TW	6040 lm	RE2110	659,66 €	785,00 €
					2200-4000 K TW + C	6040 lm	RE2110C	785,71 €	935,00 €
●	450 schwarz 450 black	LED	TRIAC 0-10 V	40 W	2700 K	4900 lm	RE2201	525,21 €	625,00 €
					3000 K	5000 lm	RE2202	525,21 €	625,00 €
					2700 K	5700 lm	RE2203	571,43 €	680,00 €
			DALI	50 W	3000 K	5800 lm	RE2204	571,43 €	680,00 €
					2200-4000 K TW	6040 lm	RE2205	659,66 €	785,00 €
					2200-4000 K TW + C	6040 lm	RE2205C	785,71 €	935,00 €
○	450 weiß 450 white	LED	TRIAC 0-10 V	40 W	2700 K	4900 lm	RE2206	525,21 €	625,00 €
					3000 K	5000 lm	RE2207	525,21 €	625,00 €
					2700 K	5700 lm	RE2208	571,43 €	680,00 €
			DALI	50 W	3000 K	5800 lm	RE2209	571,43 €	680,00 €
					2200-4000 K TW	6040 lm	RE2210	659,66 €	785,00 €
					2200-4000 K TW + C	6040 lm	RE2210C	785,71 €	935,00 €

Abbildung figure	Beschreibung description	Leuchtmittel lamp	Regelung control	Leistung power	CCT	Lumen lumen	Art.-Nr. art.-no.	€ netto DE excl. VAT	€ brutto DE incl. VAT
●	<b>600 schwarz</b> 600 black	LED	TRIAC 0–10 V	40 W	2700 K	4900 lm	RE2301	525,21 €	625,00 €
					3000 K	5000 lm	RE2302	525,21 €	625,00 €
					2700 K	5700 lm	RE2303	571,43 €	680,00 €
			DALI	50 W	3000 K	5800 lm	RE2304	571,43 €	680,00 €
					2200–4000 K TW	6040 lm	RE2305	659,66 €	785,00 €
					2200–4000 K TW + C	6040 lm	RE2305C	785,71 €	935,00 €
○	<b>600 weiß</b> 600 white	LED	TRIAC 0–10 V	40 W	2700 K	4900 lm	RE2306	525,21 €	625,00 €
					3000 K	5000 lm	RE2307	525,21 €	625,00 €
					2700 K	5700 lm	RE2308	571,43 €	680,00 €
			DALI	50 W	3000 K	5800 lm	RE2309	571,43 €	680,00 €
					2200–4000 K TW	6040 lm	RE2310	659,66 €	785,00 €
					2200–4000 K TW + C	6040 lm	RE2310C	785,71 €	935,00 €

## REFLEX<sup>2</sup> Ceiling M Reflektor

Abbildung figure	Beschreibung description	Art.-Nr. art.-no.	€ netto DE excl. VAT	€ brutto DE incl. VAT
○	<b>Pyramidenstruktur weiß</b> pyramid structure white	RE3001	96,64 €	115,00 €
●	<b>Pyramidenstruktur silber</b> pyramid structure silver	RE3002	96,64 €	115,00 €
●	<b>Pyramidenstruktur gold</b> pyramid structure gold	RE3003	96,64 €	115,00 €
○	<b>matt weiß</b> matte white	RE3004	96,64 €	115,00 €

## SLICE<sup>2</sup> PI Ceiling

Mit dem Kreis als perfekte Form bietet die Deckenleuchte SLICE<sup>2</sup> PI Ceiling die universelle Lichtlösung für alle Anforderungen moderner Architektur hinsichtlich Lichtleistung und Ausleuchtung. Ideales, blendfreies Licht wird seitlich über die Glaskante eingespeist und von einer mikroprismatischen Scheibe nach unten verteilt – Wahlweise mit zusätzlichem Indirektlicht zur Deckenaufhellung. Das komplett geschlossene Gehäuse, die Echtglasscheibe und der robuste Aluminiumring sind von substanzieller Qualität. Durch die einfache Montage mittels Bajonettverschluss, der sowohl mechanischen als auch elektrischen Kontakt herstellt, lassen sich problemlos auch große Projekte realisieren.



With the circle as the perfect shape, the SLICE<sup>2</sup> PI Ceiling luminaire offers the universal lighting solution for all requirements of modern architecture in terms of light output and illumination. Ideal, glare-free downward light is fed in laterally via the edge of the glass and distributed downward by a microprismatic pane – optionally with additional indirect light to lighten up the ceiling. The completely enclosed housing, the real glass pane and the robust aluminum ring are of substantial quality. Simple mounting by means of a bayonet catch, that establishes both mechanical and electrical contact, makes it easy to realise even large projects.

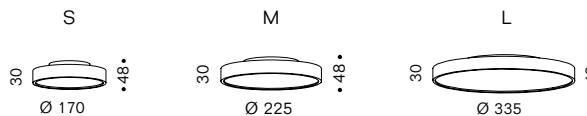

**Licht**  
light **nach unten entblendet durch Mikroprismen-Strukturglas, optional nach oben dezent diffus, UGR<19**  
downward glare-reduced by micro-prismatic structural glass; optional upward subtly diffused, UGR<19

**Leuchtmittel**  
lamp **LED 10/13/20 W, CRI Ra>95, EEK/EEC D (2700 K), C (3000 K)**







**Gehäuse**  
housing **Aluminium schwarz oder weiß beschichtet, Aluminium glanzverchromt**  
aluminum black or white coated, aluminum chrome plated

**Material**  
material **Baldachin: opales Spritzgussgehäuse; Abdeckung Acrylglas Diffusor;**  
**Leuchteneinheit: Prismenstruktur-Acrylglas mit abschließender Echtglasscheibe**  
canopy: injection moulded housing opal, cover acrylic diffuser;  
lighting unit: prismatic structured acrylic glass sealed by real glass pane









**Sonstiges**  
features **einfache Montage durch Bajonettverschluss**  
easy assembly through bayonet lock





## SLICE<sup>2</sup> PI Ceiling S

Abbildung figure	Beschreibung description	Leuchtmittel lamp	Regelung control	Leistung power	CCT	Lumen lumen	Art.-Nr. art.-no.	€ netto DE excl. VAT	€ brutto DE incl. VAT
	<b>Treibereinheit S</b> driver unit S		TRIAC	13 W			DE011001	67,23 €	80,00 €
			DALI	10 W			DE011002	84,03 €	100,00 €
● 	<b>Gehäuse S schwarz</b> housing S black	LED			2700 K	1460 lm	PI1001	239,50 €	285,00 €
					3000 K	1500 lm	PI1002	239,50 €	285,00 €
● 	<b>Gehäuse S schwarz, mit Indirektlicht</b> housing S black, with indirect light	LED			2700 K	1460 lm	PI1011	239,50 €	285,00 €
					3000 K	1500 lm	PI1012	239,50 €	285,00 €
○ 	<b>Gehäuse S weiß</b> housing S white	LED			2700 K	1460 lm	PI1021	239,50 €	285,00 €
					3000 K	1500 lm	PI1022	239,50 €	285,00 €
○ 	<b>Gehäuse S weiß, mit Indirektlicht</b> housing S white, with indirect light	LED			2700 K	1460 lm	PI1031	239,50 €	285,00 €
					3000 K	1500 lm	PI1032	239,50 €	285,00 €
● 	<b>Gehäuse S glanzverchromt</b> housing S chrome-plated	LED			2700 K	1460 lm	PI1041	273,11 €	325,00 €
					3000 K	1500 lm	PI1042	273,11 €	325,00 €
● 	<b>Gehäuse S glanzverchromt, mit Indirektlicht</b> housing S chrome-plated, with indirect light	LED			2700 K	1460 lm	PI1051	273,11 €	325,00 €
					3000 K	1500 lm	PI1052	273,11 €	325,00 €

## SLICE<sup>2</sup> PI Ceiling M

Abbildung figure	Beschreibung description	Leuchtmittel lamp	Regelung control	Leistung power	CCT	Lumen lumen	Art.-Nr. art.-no.	€ netto DE excl. VAT	€ brutto DE incl. VAT
	<b>Treibereinheit M</b> driver unit M		TRIAC	16 W			DE011011	79,83 €	95,00 €
			DALI	15 W			DE011012	113,45 €	135,00 €
● 	<b>Gehäuse M schwarz</b> housing M black	LED			2700 K	1940 lm	PI1101	327,73 €	390,00 €
					3000 K	2000 lm	PI1102	327,73 €	390,00 €
● 	<b>Gehäuse M schwarz, mit Indirektlicht</b> housing M black, with indirect light	LED			2700 K	1940 lm	PI1111	327,73 €	390,00 €
					3000 K	2000 lm	PI1112	327,73 €	390,00 €
○ 	<b>Gehäuse M weiß</b> housing M white	LED			2700 K	1940 lm	PI1121	327,73 €	390,00 €
					3000 K	2000 lm	PI1122	327,73 €	390,00 €
○ 	<b>Gehäuse M weiß, mit Indirektlicht</b> housing M white, with indirect light	LED			2700 K	1940 lm	PI1131	327,73 €	390,00 €
					3000 K	2000 lm	PI1132	327,73 €	390,00 €
● 	<b>Gehäuse M glanzverchromt</b> housing M chrome-plated	LED			2700 K	1940 lm	PI1141	369,75 €	440,00 €
					3000 K	2000 lm	PI1142	369,75 €	440,00 €
● 	<b>Gehäuse M glanzverchromt, mit Indirektlicht</b> housing M chrome-plated, with indirect light	LED			2700 K	1940 lm	PI1151	369,75 €	440,00 €
					3000 K	2000 lm	PI1152	369,75 €	440,00 €

## SLICE<sup>2</sup> PI Ceiling L

Abbildung figure	Beschreibung description	Leuchtmittel lamp	Regelung control	Leistung power	CCT	Lumen lumen	Art.-Nr. art.-no.	€ netto DE excl. VAT	€ brutto DE incl. VAT
	<b>Treibereinheit L</b> driver unit L		TRIAC	23 W			DE011021	105,04 €	125,00 €
			DALI	23 W			DE011022	142,86 €	170,00 €
● 	<b>Gehäuse L schwarz</b> housing L black	LED			2700 K	2910 lm	PI1201	445,38 €	530,00 €
					3000 K	3000 lm	PI1202	445,38 €	530,00 €
● 	<b>Gehäuse L schwarz, mit Indirektlicht</b> housing L black, with indirect light	LED			2700 K	2910 lm	PI1211	445,38 €	530,00 €
					3000 K	3000 lm	PI1212	445,38 €	530,00 €
○ 	<b>Gehäuse L weiß</b> housing L white	LED			2700 K	2910 lm	PI1221	445,38 €	530,00 €
					3000 K	3000 lm	PI1222	445,38 €	530,00 €
○ 	<b>Gehäuse L weiß, mit Indirektlicht</b> housing L white, with indirect light	LED			2700 K	2910 lm	PI1231	445,38 €	530,00 €
					3000 K	3000 lm	PI1232	445,38 €	530,00 €
● 	<b>Gehäuse L glanzverchromt</b> housing L chrome-plated	LED			2700 K	2910 lm	PI1241	504,20 €	600,00 €
					3000 K	3000 lm	PI1242	504,20 €	600,00 €
● 	<b>Gehäuse L glanzverchromt, mit Indirektlicht</b> housing L chrome-plated, with indirect light	LED			2700 K	2910 lm	PI1251	504,20 €	600,00 €
					3000 K	3000 lm	PI1252	504,20 €	600,00 €

**ANNEX Ceiling L**  
reflector: opal glass



**ANNEX Ceiling M**  
reflector: opal glass



**ANNEX Ceiling S**  
reflector: opal glass



**ANNEX Ceiling L**  
reflector: polished aluminum



**ANNEX Ceiling M**  
reflector: polished aluminum



**ANNEX Ceiling S**  
reflector: polished aluminum



**ANNEX Ceiling L**  
reflector: crystal glass



**ANNEX Ceiling M**  
reflector: crystal glass



**ANNEX Ceiling S**  
reflector: crystal glass



















CAVITY Ceiling | CAVITY Recessed • black



CAVITY Ceiling | CAVITY Recessed • white







CAVITY Ceiling | CAVITY Recessed • aluminium gloss finish



CAVITY Ceiling | CAVITY Recessed • bronze finish





shade: glass clear  
reflector: conical opal



shade: glass clear  
reflector: cylindrical opal



shade: glass clear



shade: acrylic glass clear  
reflector: conical opal



shade: acrylic glass clear  
reflector: cylindrical opal



shade: acrylic glass clear















**DRAFT Ceiling M • clear**



**DRAFT Ceiling S • clear**



**DRAFT Ceiling M • brown**



**DRAFT Ceiling S • brown**



**DRAFT Ceiling M • blue**

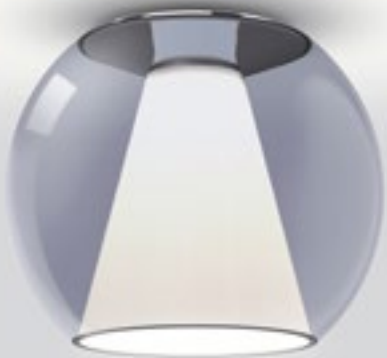

**DRAFT Ceiling S • blue**







**DRUM Ceiling M • long**



**DRUM Ceiling S • long**



**DRUM Ceiling M • short**



**DRUM Ceiling S • short**















REEF Ceiling • brushed



CEILING

REEF Ceiling • brushed





reflector: pyramid white



reflector: pyramid silver



reflector: pyramid gold

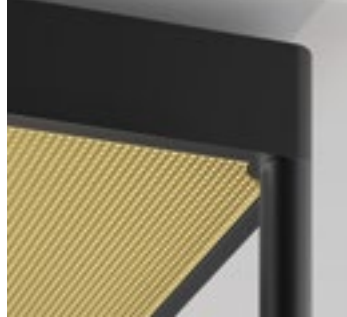

reflector: matte white

















**SLICE<sup>2</sup> PI Ceiling L · black**



**SLICE<sup>2</sup> PI Ceiling M · black**



**SLICE<sup>2</sup> PI Ceiling S · black**



**SLICE<sup>2</sup> PI Ceiling L · white**



**SLICE<sup>2</sup> PI Ceiling M · white**



**SLICE<sup>2</sup> PI Ceiling S · white**



**SLICE<sup>2</sup> PI Ceiling L · chrome**



**SLICE<sup>2</sup> PI Ceiling M · chrome**



**SLICE<sup>2</sup> PI Ceiling S · chrome**









**ANNEX**  
S. 58

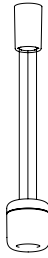

**CAVITY**  
S. 60



**CURLING**  
S. 62



**DRAFT**  
S. 66

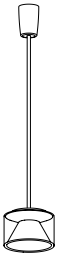

**DRUM**  
S. 68

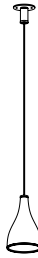

**ONE EIGHTY**  
S. 70

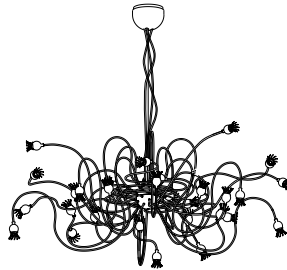

**POPPY**  
S. 72

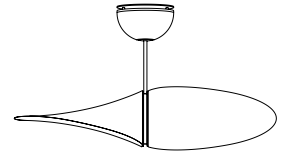

**PROPELLER**  
S. 73

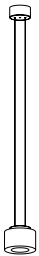

**REEF**  
S. 74

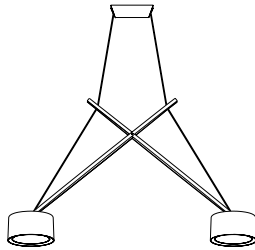

**TWIN**  
S. 75

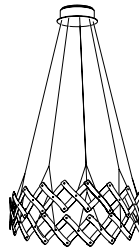

**ZOOM**  
S. 76

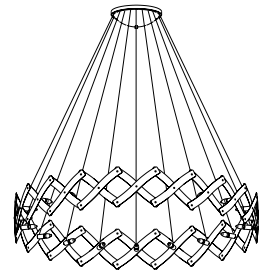

**ZOOM XL**  
S. 76



## ANNEX Suspension

Eine geradezu archetypische Deckenleuchte mit dem Mehr an Funktionalität, auf das wir Wert legen: drei verschiedene Größen korrespondieren mit den Proportionen Ihrer Räume. Mit den unterschiedlichen Reflektoren im Innern des mundgeblasenen Kegelschirms lassen sich äußerst differenzierte Lichtwirkungen erzielen, die formal dennoch einer Familie angehören.

An almost archetypal ceiling light with more functionality that we value: three different sizes correspond with the proportions of your rooms. The different reflectors inside the hand-blown cone shade make it possible to achieve extremely differentiated lighting effects that formally belong to a family.



DESIGN PLUS

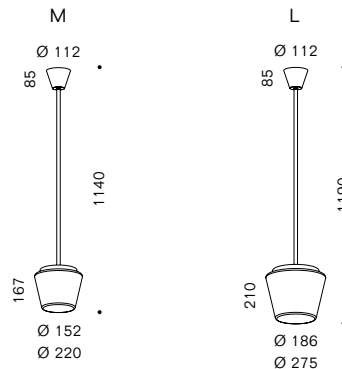

**Leuchtmittel**  
lamp LED 20–41 W, CoB, CRI Ra>97 (R9>80), EEK/EEC E (3000 K), F (2700 K)

**Leuchteneinheit**  
light unit **Aluminium, hochglanzpoliert und weiß beschichtet**  
aluminum, highly polished and coated white

**Schirm**  
shade **mundgeblasenes Glas klar**  
hand-blown glass clear

**Abhängung**  
suspension **Stahlrohr verchromt**  
chromed steel tube

**Ausführungen**  
versions



**Glasschirm klar, Reflektor Acrylglas opal**  
**Licht: nach unten gerichtet, rundum gestreut**  
glass shade clear, reflector acrylic glass opal  
light: directed downwards, distributed all around





**Glasschirm klar, Reflektor Aluminium poliert**  
**Licht: nach unten gerichtet, rundum diffus**  
glass shade clear, reflector: aluminium polished  
light: directed downwards, diffused all around





**Glasschirm klar, Reflektor Kristallglas geschliffen mit Aluminium-Innenreflektor**  
**Licht: nach unten gerichtet, rundum dekorativ**  
glass shade clear, reflector crystal glass with aluminium reflector cut crystal glass  
light: directed downwards, diffused all around

**Sonstiges**  
features **LED austauschbar; werkzeuglose Schirmmontage; 110 V-Varianten auf Anfrage**  
LED exchangeable; glass shade tool-free mountable; 110 V versions on request

## ANNEX Suspension M

Abbildung figure	Beschreibung description	Leuchtmittel lamp	Regelung control	Leistung power	CCT	Lumen lumen	Art.-Nr. art.-no.	€ netto DE excl. VAT	€ brutto DE incl. VAT
	<b>Reflektor opal</b> reflector opal	LED	TRIAC	20 W	2700 K	1450 lm	AN3101	609,24 €	725,00 €
					3000 K	1500 lm	AN3102	609,24 €	725,00 €
			DALI	27 W	2700 K	2900 lm	AN3105	642,86 €	765,00 €
					3000 K	3000 lm	AN3106	642,86 €	765,00 €
	<b>Reflektor poliert</b> reflector polished	LED	TRIAC	20 W	2700 K	1450 lm	AN3111	642,86 €	765,00 €
					3000 K	1500 lm	AN3112	642,86 €	765,00 €
			DALI	27 W	2700 K	2900 lm	AN3116	676,47 €	805,00 €
					3000 K	3000 lm	AN3117	676,47 €	805,00 €
	<b>Reflektor Kristall</b> reflector crystal	LED	TRIAC	20 W	2700 K	1450 lm	AN3121	747,90 €	890,00 €
					3000 K	1500 lm	AN3122	747,90 €	890,00 €
			DALI	27 W	2700 K	2900 lm	AN3125	781,51 €	930,00 €
					3000 K	3000 lm	AN3126	781,51 €	930,00 €

## ANNEX Suspension L

Abbildung figure	Beschreibung description	Leuchtmittel lamp	Regelung control	Leistung power	CCT	Lumen lumen	Art.-Nr. art.-no.	€ netto DE excl. VAT	€ brutto DE incl. VAT
	<b>Reflektor opal</b> reflector opal	LED	TRIAC	34 W	2700 K	3850 lm	AN3147	680,67 €	810,00 €
					3000 K	4010 lm	AN3148	680,67 €	810,00 €
			DALI	41 W	2700 K	4500 lm	AN3151	722,69 €	860,00 €
					3000 K	4680 lm	AN3152	722,69 €	860,00 €
	<b>Reflektor poliert</b> reflector polished	LED	TRIAC	34 W	2700 K	3850 lm	AN3153	722,69 €	860,00 €
					3000 K	4010 lm	AN3154	722,69 €	860,00 €
			DALI	41 W	2700 K	4500 lm	AN3157	764,71 €	910,00 €
					3000 K	4680 lm	AN3158	764,71 €	910,00 €
	<b>Reflektor Kristall</b> reflector crystal	LED	TRIAC	34 W	2700 K	3850 lm	AN3141	882,35 €	1.050,00 €
					3000 K	4010 lm	AN3142	882,35 €	1.050,00 €
			DALI	41 W	2700 K	4500 lm	AN3145	924,37 €	1.100,00 €
					3000 K	4680 lm	AN3146	924,37 €	1.100,00 €



## CAVITY Suspension

Ein speziell konzipierter, kurvenförmiger Aluminiumkörper mit vertieft sitzendem Leuchtmittel ersetzt beim Strahler CAVITY den Reflektor und erlaubt eine freie Entfaltung des Lichts, das über die Trichterform scheinbar nach außen fließt. Es entsteht ein Downlight mit einem blendfreien und sanften Licht, das aus jedem Winkel angenehm wirkt. Unterschiedliche Beleuchtungsaufgaben können einheitlich durch Kombination der Wandleuchten mit Aufbau- und Einbaustrahlern sowie den Pendelleuchten dieser Produktfamilie gelöst werden.

A specially designed, curved aluminum body including the recessed illuminant replaces the reflector in spotlight CAVITY and allows the light to unfold freely, seemingly flowing outwards via the funnel shaped form. The result is a glare-free and soft downlight, that is pleasant from all angles. Different lighting tasks can be solved consistently by combining the wall luminaires with surface-mounted and recessed spotlights and the pendant luminaires of this product family.

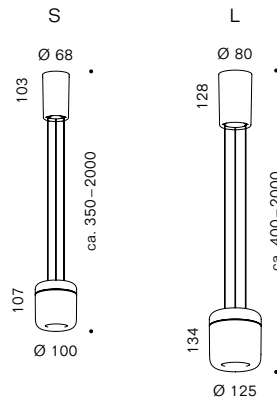

**Licht**  
light **nach unten gerichtet, seitlich abgeschirmt**  
directed downwards, shielded to the sides

**Leuchtmittel**  
lamp LED 12–20 W, CoB, CRI Ra>95 (R9>80), EEK/EEC E

**Gehäuse**  
housing **Aluminium schwarz oder weiß beschichtet, Aluminiumglanz finish oder Bronze finish**  
aluminum black or white coated, aluminum gloss finish or bronze finish

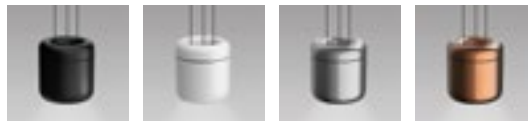

**Sonstiges**  
features **LED austauschbar, werkzeuglose Gehäusemontage; geeignet für Deckenhöhen bis 3 m, Sonderlängen und 110 V-Varianten auf Anfrage**  
LED exchangeable; housing tool-free mountable; suitable for ceiling heights up to 3 m, special lengths and 110 V versions on request

## CAVITY Suspension S

Abbildung figure	Beschreibung description	Leuchtmittel lamp	Regelung control	Leistung power	CCT	Lumen lumen	Art.-Nr. art.-no.	€ netto DE excl. VAT	€ brutto DE incl. VAT
●	<b>schwarz</b> black	LED	TRIAC	10 W	2700 K	950 lm	CA1101	327,73 €	390,00 €
					3000 K	1000 lm	CA1102	327,73 €	390,00 €
○	<b>weiß</b> white	LED	TRIAC	10 W	2700 K	950 lm	CA1103	327,73 €	390,00 €
					3000 K	1000 lm	CA1104	327,73 €	390,00 €
●	<b>Aluminiumglanz finish</b> aluminum gloss finish	LED	TRIAC	10 W	2700 K	950 lm	CA1105	394,96 €	470,00 €
					3000 K	1000 lm	CA1106	394,96 €	470,00 €
●	<b>Bronze finish</b> bronze finish	LED	TRIAC	10 W	2700 K	950 lm	CA1107	394,96 €	470,00 €
					3000 K	1000 lm	CA1108	394,96 €	470,00 €

## CAVITY Suspension L

Abbildung figure	Beschreibung description	Leuchtmittel lamp	Regelung control	Leistung power	CCT	Lumen lumen	Art.-Nr. art.-no.	€ netto DE excl. VAT	€ brutto DE incl. VAT
●	<b>schwarz</b> black	LED	TRIAC	20 W	2700 K	1910 lm	CA2101	457,98 €	545,00 €
					3000 K	2010 lm	CA2102	457,98 €	545,00 €
			DALI	20 W	2700 K	1910 lm	CA2105	512,61 €	610,00 €
					3000 K	2010 lm	CA2106	512,61 €	610,00 €
○	<b>weiß</b> white	LED	TRIAC	20 W	2700 K	1910 lm	CA2107	457,98 €	545,00 €
					3000 K	2010 lm	CA2108	457,98 €	545,00 €
			DALI	20 W	2700 K	1910 lm	CA2111	512,61 €	610,00 €
					3000 K	2010 lm	CA2112	512,61 €	610,00 €
●	<b>Aluminiumglanz finish</b> aluminum gloss finish	LED	TRIAC	20 W	2700 K	1910 lm	CA2113	546,22 €	650,00 €
					3000 K	2010 lm	CA2114	546,22 €	650,00 €
			DALI	20 W	2700 K	1910 lm	CA2117	600,84 €	715,00 €
					3000 K	2010 lm	CA2118	600,84 €	715,00 €
●	<b>Bronze finish</b> bronze finish	LED	TRIAC	20 W	2700 K	1910 lm	CA2119	546,22 €	650,00 €
					3000 K	2010 lm	CA2120	546,22 €	650,00 €
			DALI	20 W	2700 K	1910 lm	CA2123	600,84 €	715,00 €
					3000 K	2010 lm	CA2124	600,84 €	715,00 €

## CAVITY Suspension L – Zubehör / Accessories

**Baldachinprofil**  
Canopy profiles

**Baldachine für die Montage von 2 oder 3 CAVITY Suspension L an einem Deckenauslass finden Sie auf den Seiten 198–199.**  
Canopies for mounting 2 or 3 CAVITY Suspension L on one ceiling outlet can be found on pages 198–199.

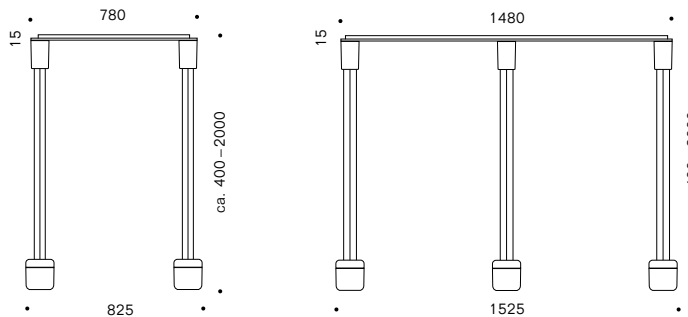

CAVITY Suspension L

# CURLING Suspension







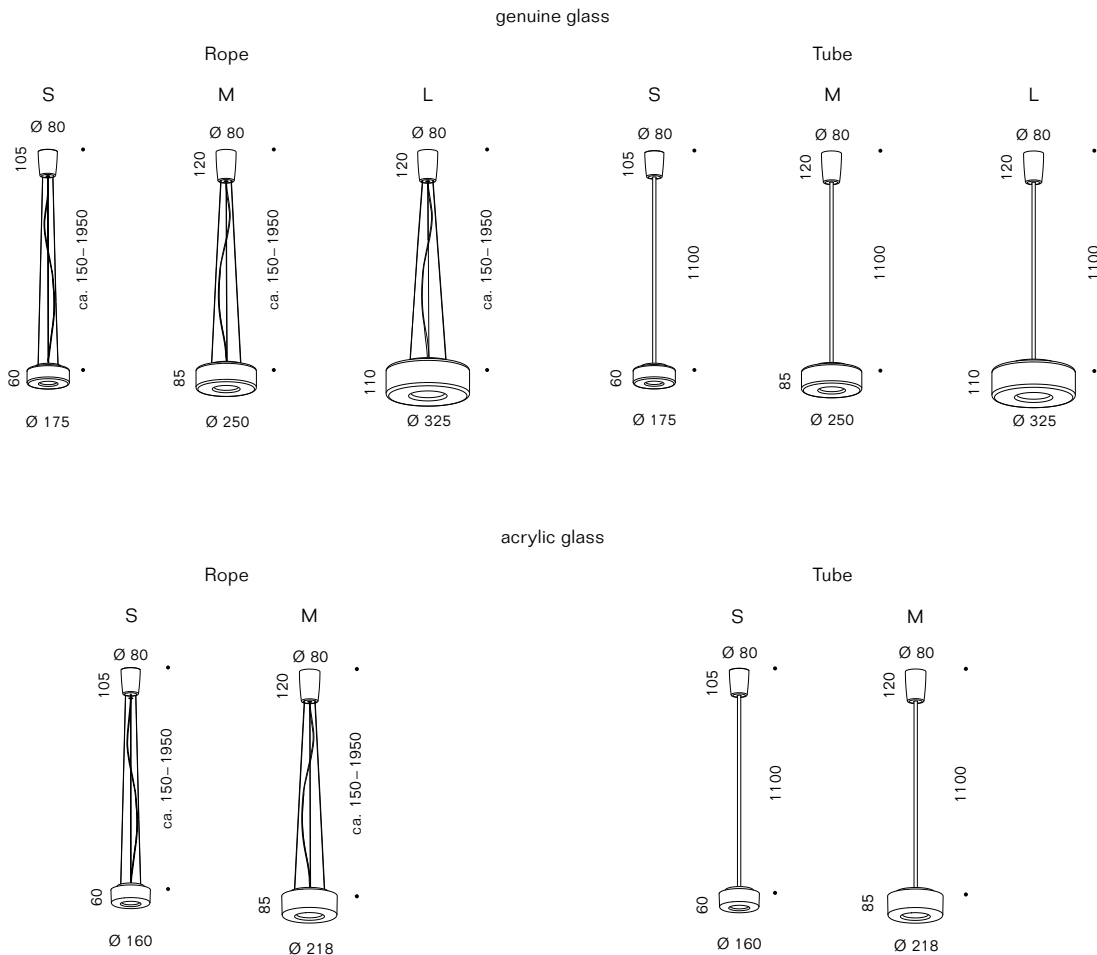

Klare Formen und intelligente Gestaltungsdetails machen CURLING Suspension zum universell einsetzbaren Downlight und Raumlicht in einem. Das ermöglicht besonders bei hohen Decken für jede Raumsituation und jede Raumhöhe die perfekte Lichtstimmung. CURLING Suspension kombiniert nach unten gerichtetes Direktlicht mit sanftem Raumlicht. Versionen mit Acrylglasschirm in kantiger Ästhetik erweitert das Einsatzspektrum von CURLING und ermöglichen einen optimalen Einsatz in Schulen, Kindergärten, Treppenhäusern und anderen Verkehrswegen im halböffentlichen oder öffentlichen Raum.



With its clear shape and intelligent design CURLING Suspension is an all-round downlight and ceiling light rolled into one. This means that in any setting you can rely on the perfect light mood. CURLING Suspension combines light directed downward with softly diffusing ambient light. Versions with acrylic glass shade in angular aesthetics expand CURLING's range of applications and enable optimal use in schools, kindergartens, stairwells and other paths in semi-public and public spaces.



<b>Leuchtmittel</b> lamp	LED 11–34 W, CoB, CRI Ra>97 (R9>80), EEK/EEC F (2700 K, 3000 K), G (1800–3000 K D2W)
<b>Leuchteneinheit</b> light unit	Aluminium hochglanzpoliert aluminum highly polished
<b>Abhängung</b> suspension	Edelstahlseil oder Stahlrohr verchromt stainless steel rope or chromed steel tube

<b>Schirm</b> shade	<b>mundgeblasenes Glas klar, opal oder metallisiert</b> <b>Reflektor: Polycarbonat opal</b> mundgeblasenes Glas klar, opal oder metallisiert Reflektor: Polycarbonat opal	<b>Acrylglas klar</b> <b>Reflektor: Polycarbonat opal</b> Acrylic glass clear reflector: polycarbonate opal
<b>Ausführungen</b> versions	 <b>Glasschirm klar</b> <b>Licht: nach unten gerichtet, rundum abstrahlend</b> glass shade clear light: directed downwards, distributed all around	 <b>Acrylglasschirm klar</b> <b>Licht: nach unten gerichtet, rundum abstrahlend</b> acrylic glass shade clear light: directed downwards, distributed all around
	 <b>Glasschirm klar, Reflektor konisch</b> <b>Licht: nach unten gerichtet, rundum weich gestreut</b> glass shade clear, reflector conical light: directed downwards, diffused all around	 <b>Acrylglasschirm klar, Reflektor konisch</b> <b>Licht: nach unten gerichtet, rundum weich gestreut</b> acrylic glass shade clear, reflector conical light: directed downwards, diffused all around
	 <b>Glasschirm klar, Reflektor zylindrisch</b> <b>Licht: nach unten gerichtet, rundum weich gestreut</b> shade glass clear, reflector cylindrical light: directed downwards, diffused all around	 <b>Acrylglasschirm klar, Reflektor zylindrisch</b> <b>Licht: nach unten gerichtet, rundum weich gestreut</b> acrylic glass shade clear, reflector cylindrical light: directed downwards, diffused all around
	 <b>Glasschirm opal</b> <b>Licht: nach unten gerichtet, rundum weich gestreut</b> glass shade opal light: directed downwards, diffused all around	
	 <b>Glasschirm neusilber</b> <b>Licht: nach unten gerichtet, rundum abstrahlend</b> glass shade new silver light: directed downwards, distributed all around	
<b>Sonstiges</b> features	<b>LED wechselbar, werkzeuglose Schirmmontage; 110 V-Varianten auf Anfrage; DALI-Varianten für den Einsatz in Notbeleuchtungsanlagen auf Anfrage</b> LED exchangeable, shade tool-free mountable; 110 V versions on request; DALI versions for the use in emergency lighting systems on request	

CURLING ist ein modularer Artikel. Bitte jeweils Leuchteneinheit und Glasschirm zusammen bestellen.  
 CURLING is a modular article. Please order the lighting unit and glass shade together.





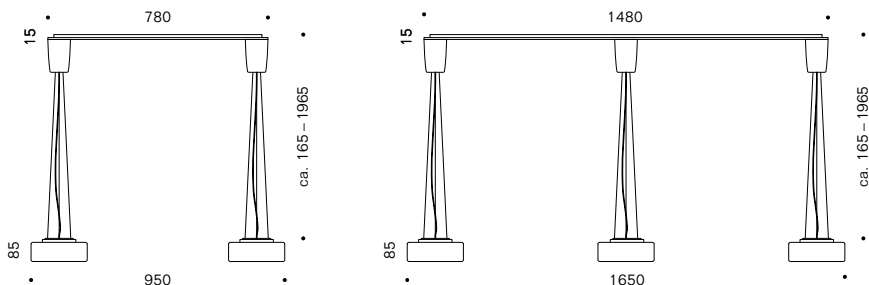





## CURLING Suspension S/M – Zubehör / Accessories

**Baldachinprofile** Baldachine für 2 oder 3 CURLING Suspension an einem Deckenauslass finden Sie auf Seiten 198–199.  
**Canopy profiles** Canopies for mounting zwei oder drei of CURLING Suspension on one ceiling outlet can be found on pages 198–199.













CURLING Suspension Rope M







## CURLING Suspension S

Abbildung figure	Beschreibung description	Leuchtmittel lamp	Regelung control	Leistung power	CCT	Lumen lumen	Art.-Nr. art.-no.	€ netto DE € excl. VAT	brutto DE € incl. VAT
	<b>Rope Leuchteinheit S</b> Rope lighting unit S	LED	TRIAC	11 W	2700 K	1130 lm	LE015704	352,94 €	420,00 €
					3000 K	1180 lm	LE015705	352,94 €	420,00 €
					1800–3000 K D2W	870 lm	LE015706	382,35 €	455,00 €
			DALI	11 W	2700 K	1130 lm	LE015735	382,35 €	455,00 €
					3000 K	1180 lm	LE015736	382,35 €	455,00 €
					1800–3000 K D2W	870 lm	LE015737	411,76 €	490,00 €
	<b>Tube Leuchteinheit S</b> Tube lighting unit S	LED	TRIAC	11 W	2700 K	1130 lm	LE015707	315,13 €	375,00 €
					3000 K	1180 lm	LE015708	315,13 €	375,00 €
					1800–3000 K D2W	870 lm	LE015709	344,54 €	410,00 €
			DALI	11 W	2700 K	1130 lm	LE015740	344,54 €	410,00 €
					3000 K	1180 lm	LE015741	344,54 €	410,00 €
					1800–3000 K D2W	870 lm	LE015742	373,95 €	445,00 €
	<b>Glas S klar</b> glass S clear						CU014406	180,67 €	215,00 €
	<b>Glas S klar, Reflektor konisch</b> glass S clear, reflector conical						CU014407	201,68 €	240,00 €
	<b>Glas S klar, Reflektor zylindrisch</b> glass S clear, reflector cylindrical						CU014408	201,68 €	240,00 €
	<b>Glas S opal</b> glass S opal						CU014405	172,27 €	205,00 €
	<b>Glas S neusilber</b> glass S new silver						CU011201	256,30 €	305,00 €
	<b>Acrylglas S klar</b> acrylic glass S clear						CU011203	75,63 €	90,00 €
	<b>Acrylglas S klar, Reflektor konisch</b> acrylic glass S clear, reflector conical						CU011204	92,44 €	110,00 €
	<b>Acrylglas S klar, Reflektor zylindrisch</b> acrylic glass S clear, reflector cylindrical						CU011205	92,44 €	110,00 €

## CURLING Suspension M

Abbildung figure	Beschreibung description	Leuchtmittel lamp	Regelung control	Leistung power	CCT	Lumen lumen	Art.-Nr. art.-no.	€ netto DE excl. VAT	€ brutto DE incl. VAT
	<b>Rope Leuchteneinheit M</b> Rope lighting unit M	LED	TRIAC 0–10 V	27 W	2700 K	2610 lm	LE015716	424,37 €	505,00 €
					3000 K	2750 lm	LE015717	424,37 €	505,00 €
					1800–3000 K D2W	2180 lm	LE015718	462,18 €	550,00 €
			DALI	27 W	2700 K	2610 lm	LE015719	453,78 €	540,00 €
					3000 K	2750 lm	LE015720	453,78 €	540,00 €
					1800–3000 K D2W	2180 lm	LE015721	491,60 €	585,00 €
	<b>Tube Leuchteneinheit M</b> Tube lighting unit M	LED	TRIAC 0–10 V	27 W	2700 K	2610 lm	LE015722	382,35 €	455,00 €
					3000 K	2750 lm	LE015723	382,35 €	455,00 €
					1800–3000 K D2W	2180 lm	LE015724	420,17 €	500,00 €
			DALI	27 W	2700 K	2610 lm	LE015725	411,76 €	490,00 €
					3000 K	2750 lm	LE015726	411,76 €	490,00 €
					1800–3000 K D2W	2180 lm	LE015727	449,58 €	535,00 €
	<b>Glas M klar</b> glass M clear						CU014402	226,89 €	270,00 €
	<b>Glas M klar, Reflektor konisch</b> glass M clear, reflector conical						CU014403	252,10 €	300,00 €
	<b>Glas M klar, Reflektor zylindrisch</b> glass M clear, reflector cylindrical						CU014404	252,10 €	300,00 €
	<b>Glas M opal</b> glass M opal						CU014401	214,29 €	255,00 €
	<b>Glas M neusilber</b> glass M new silver						CU011202	323,53 €	385,00 €
	<b>Acrylglas M klar</b> acrylic glass M clear						CU011206	100,84 €	120,00 €
	<b>Acrylglas M klar, Reflektor konisch</b> acrylic glass M clear, reflector conical						CU011207	126,05 €	150,00 €
	<b>Acrylglas M klar, Reflektor zylindrisch</b> acrylic glass M clear, reflector cylindrical						CU011208	126,05 €	150,00 €

## CURLING Suspension L

Abbildung figure	Beschreibung description	Leuchtmittel lamp	Regelung control	Leistung power	CCT	Lumen lumen	Art.-Nr. art.-no.	€ netto DE excl. VAT	€ brutto DE incl. VAT			
	<b>Rope Leuchteneinheit L</b> Rope lighting unit L	LED	TRIAC	34 W	2700 K	3360 lm	LE014486	462,18 €	550,00 €			
					3000 K	3480 lm	LE014489	462,18 €	550,00 €			
					DALI	34 W	2700 K	3360 lm	LE014484	500,00 €	595,00 €	
			3000 K	3480 lm	LE014487		500,00 €	595,00 €				
				<b>Tube Leuchteneinheit L</b> Tube lighting unit L	LED	TRIAC	34 W	2700 K	3360 lm	LE014492	415,97 €	495,00 €
								3000 K	3480 lm	LE014495	415,97 €	495,00 €
DALI	34 W	2700 K						3360 lm	LE014490	453,78 €	540,00 €	
3000 K		3480 lm				LE014493	453,78 €	540,00 €				
	<b>Glas L klar</b> glass clear									CU014475	310,92 €	370,00 €
	<b>Glas L klar, Reflektor konisch</b> glass clear, reflector conical									CU014476	344,54 €	410,00 €
	<b>Glas L klar, Reflektor zylindrisch</b> glass clear, reflector cylindrical						CU014477	344,54 €	410,00 €			
	<b>Glas L neusilber</b> glass L new silver						CU014478	399,16 €	475,00 €			

## DRAFT Suspension

**DRAFT macht aus der archetypischen Kugelleuchte ein Objekt von zeitgenössischer Prägnanz und perfekt ausbalancierter Lichtwirkung. Die transparente, mundgeblasene Glaskugel und der lichtdurchlässige, mattweiße Innenreflektor treten in einen spannenden Kontrast. Das LED-Leuchtmittel tief im Inneren des konischen Reflektors sorgt rundum für weich gestreutes Raumlicht und gerichtetes Licht nach unten. Eine Diffusorscheibe gewährleistet einen besonders weichen Lichtaustritt und gleichmäßig beleuchtete Flächen. DRAFT ist absolut blendfrei, verfügt über zwei verschiedene Lichtfarben und die Dim2warm-Funktion.**

DRAFT turns the archetypal spherical luminaire into an object that boasts an unpretentious contemporary look and perfectly balanced light. The transparent, hand-blown glass ball and the translucent, matte white internal reflector make for a striking contrast. Set deep in the internal reflector, the LED illuminant delivers softly diffused all-round and downward directional light. A diffuser plate ensures particularly soft light and evenly illuminated spaces. DRAFT is absolutely glare-free, comes with two different light colors and the Dim2warm function.

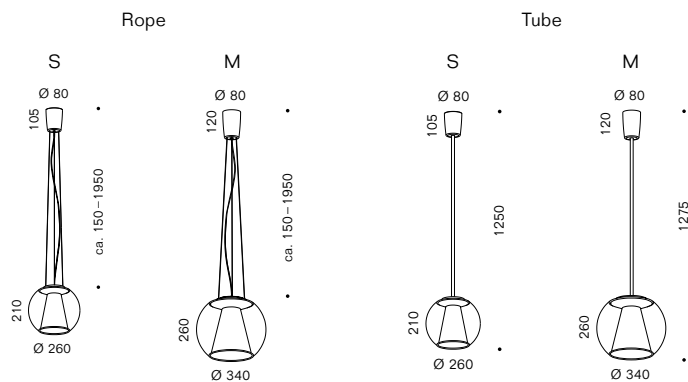

**Leuchtmittel**  
lamp LED 11-27 W, CoB, CRI Ra>97 (R9>80), EEK/EEC F (2700 K, 3000 K), G (1800-3000 K D2W)

**Leuchteneinheit**  
light unit **Aluminium hochglanzpoliert**  
aluminum highly polished

**Schirm**  
shade **mundgeblasenes Glas klar, Reflektor: Acrylglas opal**  
hand-blown glass clear; reflector: acrylic glass opal





**Ausführungen**  
versions **Glasschirm klar, Reflektor konisch opal; Licht: nach unten gerichtet, rundum weich gestreut**  
glass shade clear, reflector conical; light: directed downwards, diffused all around





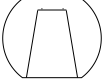

**Sonstiges**  
features **LED wechselbar, werkzeuglose Schirmmontage; 110 V-Varianten auf Anfrage;**  
**DALI-Varianten für den Einsatz in Notbeleuchtungsanlagen auf Anfrage**  
LED exchangeable, shade tool-free mountable; 110 V versions on request;  
DALI Versions for the use in emergency lighting systems on request

**DRAFT ist ein modularer Artikel. Bitte jeweils Leuchteneinheit und Glasschirm zusammen bestellen.**  
DRAFT is a modular article. Please order the lighting unit and glass shade together.

## DRAFT Suspension S

Abbildung figure	Beschreibung description	Leuchtmittel lamp	Regelung control	Leistung power	CCT	Lumen lumen	Art.-Nr. art.-no.	€ netto DE excl. VAT	€ brutto DE incl. VAT
	<b>Rope Leuchteneinheit S</b> Rope lighting unit S	LED	TRIAC	11 W	2700 K	1130 lm	LE015704	352,94 €	420,00 €
					3000 K	1180 lm	LE015705	352,94 €	420,00 €
					1800–3000 K D2W	870 lm	LE015706	382,35 €	455,00 €
			DALI	11 W	2700 K	1130 lm	LE015735	382,35 €	455,00 €
					3000 K	1180 lm	LE015736	382,35 €	455,00 €
					1800–3000 K D2W	870 lm	LE015737	411,76 €	490,00 €
	<b>Tube Leuchteneinheit S</b> Tube lighting unit S	LED	TRIAC	11 W	2700 K	1130 lm	LE015707	315,13 €	375,00 €
					3000 K	1180 lm	LE015708	315,13 €	375,00 €
					1800–3000 K D2W	870 lm	LE015709	344,54 €	410,00 €
			DALI	11 W	2700 K	1130 lm	LE015740	344,54 €	410,00 €
					3000 K	1180 lm	LE015741	344,54 €	410,00 €
					1800–3000 K D2W	870 lm	LE015742	373,95 €	445,00 €
	<b>Glas S klar mit Reflektor</b> glass S clear with reflector						DR015728	247,90 €	295,00 €
	<b>Glas S braun mit Reflektor</b> glass S brown with reflector						DR015729	285,71 €	340,00 €
	<b>Glas S blau mit Reflektor</b> glass S blue with reflector						DR015730	285,71 €	340,00 €

## DRAFT Suspension M

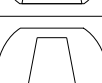
Abbildung figure	Beschreibung description	Leuchtmittel lamp	Regelung control	Leistung power	CCT	Lumen lumen	Art.-Nr. art.-no.	€ netto DE excl. VAT	€ brutto DE incl. VAT
	<b>Rope Leuchteneinheit M</b> Rope lighting unit M	LED	TRIAC	27 W	2700 K	2610 lm	LE015716	424,37 €	505,00 €
					3000 K	2750 lm	LE015717	424,37 €	505,00 €
					1800–3000 K D2W	2180 lm	LE015718	462,18 €	550,00 €
			DALI	27 W	2700 K	2610 lm	LE015719	453,78 €	540,00 €
					3000 K	2750 lm	LE015720	453,78 €	540,00 €
					1800–3000 K D2W	2180 lm	LE015721	491,60 €	585,00 €
	<b>Tube Leuchteneinheit M</b> Tube lighting unit M	LED	TRIAC	27 W	2700 K	2610 lm	LE015722	382,35 €	455,00 €
					3000 K	2750 lm	LE015723	382,35 €	455,00 €
					1800–3000 K D2W	2180 lm	LE015724	420,17 €	500,00 €
			DALI	27 W	2700 K	2610 lm	LE015725	411,76 €	490,00 €
					3000 K	2750 lm	LE015726	411,76 €	490,00 €
					1800–3000 K D2W	2180 lm	LE015727	449,58 €	535,00 €
	<b>Glas M klar mit Reflektor</b> glass M clear with reflector						DR015731	327,73 €	390,00 €
	<b>Glas M braun mit Reflektor</b> glass M brown with reflector						DR015732	373,95 €	445,00 €
	<b>Glas M blau mit Reflektor</b> glass M blue with reflector						DR015733	373,95 €	445,00 €

## DRAFT Suspension S / M – Zubehör / Accessories

**Baldachinprofile** Baldachine für die Montage von zwei oder drei DRAFT Suspension an nur einem Deckenauslass finden Sie auf Seiten 198–199.  
Canopy profiles Canopies for mounting 2 or drei DRUM Suspension on only one ceiling outlet can be found on pages 198–199.



## DRUM Suspension

**DRUM Suspension** holt die schlichte Zylinderform von der Decke in den Raum und spielt mit dem geometrisch angepassten Volumen des opalen Innenreflektors. **DRUM Suspension Tube** passt mit ihrem rundum mild gestreuten Licht und gerichtetem Licht nach unten besonders gut in Flure oder Treppenhäuser, **DRUM Suspension Rope** mit ihrer feinen Stahlseilabhängung über Tische und Theken. **DRUM** ist absolut blendfrei, verfügt über zwei verschiedene Lichtfarben und die Dim2warm-Funktion.

DRUM Suspension brings the straightforward cylindrical shape down into the room and playfully deploys the geometrically adjusted volume of the opale internal reflector. DRUM Suspension Tube which diffuses light so mildly right round, directing light carefully downward, is ideal for corridors or stairwells, DRUM Suspension Rope with its fine steel cable suspension fits well over tables or bar tops. DRUM is absolutely glare-free, comes with two different light colors and the Dim2warm function.

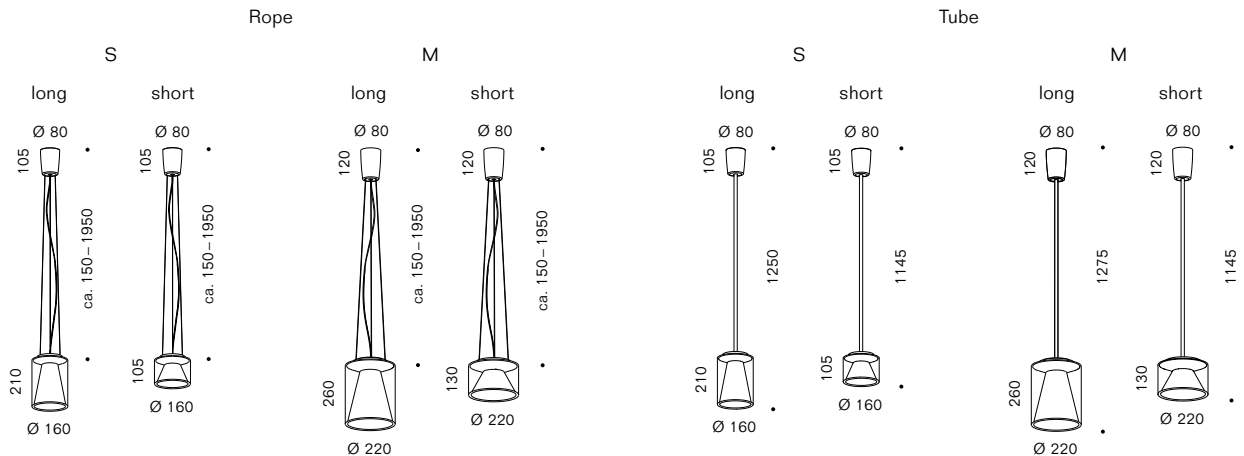

**Licht**  
light **nach unten gerichtet, rundum weich gestreut**  
directed downwards, diffused all around

**Leuchtmittel**  
lamp LED 11–27 W, CoB, CRI Ra>97 (R9>80), EEK/EEC F (2700 K, 3000 K), G (1800–3000 K D2W)

**Leuchteneinheit**  
light unit **Aluminium hochglanzpoliert**  
aluminum highly polished

**Glasschirm**  
glass shade **mundgeblasenes Glas klar, Reflektor: Acrylglas opal**  
hand-blown glass clear; reflector: acrylic glass opal

**Abhängung**  
suspension **Edelstahlseil oder Stahlrohr verchromt**  
stainless steel rope or chromed steel tube



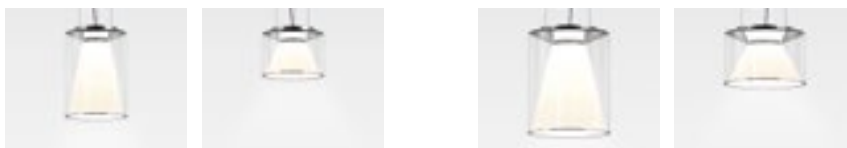

**Ausführungen**  
versions







**Sonstiges**  
features **LED wechselbar, werkzeuglose Schirmmontage; 110 V-Varianten auf Anfrage; DALI-Varianten für den Einsatz in Notbeleuchtungsanlagen auf Anfrage**  
LED exchangeable, shade tool-free mountable; 110 V versions on request; DALI versions for the use in emergency lighting systems on request

**DRUM ist ein modularer Artikel. Bitte jeweils Leuchteneinheit und Glasschirm zusammen bestellen.**  
DRUM is a modular article. Please order the lighting unit and glass shade together.

## DRUM Suspension S

Abbildung figure	Beschreibung description	Leuchtmittel lamp	Regelung control	Leistung power	CCT	Lumen lumen	Art.-Nr. art.-no.	€ netto DE excl. VAT	€ brutto DE incl. VAT
	<b>Rope Leuchteinheit S</b> Rope lighting unit S	LED	TRIAC	11 W	2700 K	1130 lm	LE015704	352,94 €	420,00 €
					3000 K	1180 lm	LE015705	352,94 €	420,00 €
					1800–3000 K D2W	870 lm	LE015706	382,35 €	455,00 €
			DALI	11 W	2700 K	1130 lm	LE015735	382,35 €	455,00 €
					3000 K	1180 lm	LE015736	382,35 €	455,00 €
					1800–3000 K D2W	870 lm	LE015737	411,76 €	490,00 €
	<b>Tube Leuchteinheit S</b> Tube lighting unit S	LED	TRIAC	11 W	2700 K	1130 lm	LE015707	315,13 €	375,00 €
					3000 K	1180 lm	LE015708	315,13 €	375,00 €
					1800–3000 K D2W	870 lm	LE015709	344,54 €	410,00 €
			DALI	11 W	2700 K	1130 lm	LE015740	344,54 €	410,00 €
					3000 K	1180 lm	LE015741	344,54 €	410,00 €
					1800–3000 K D2W	870 lm	LE015742	373,95 €	445,00 €
	<b>Glas S long mit Reflektor</b> glass S long with reflector						DU015801	189,08 €	225,00 €
	<b>Glas S short mit Reflektor</b> glass S short with reflector						DU015802	142,86 €	170,00 €

## DRUM Suspension M

Abbildung figure	Beschreibung description	Leuchtmittel lamp	Regelung control	Leistung power	CCT	Lumen lumen	Art.-Nr. art.-no.	€ netto DE excl. VAT	€ brutto DE incl. VAT
	<b>Rope Leuchteinheit M</b> Rope lighting unit M	LED	TRIAC	27 W	2700 K	2610 lm	LE015716	424,37 €	505,00 €
					3000 K	2750 lm	LE015717	424,37 €	505,00 €
					1800–3000 K D2W	2180 lm	LE015718	462,18 €	550,00 €
			DALI	27 W	2700 K	2610 lm	LE015719	453,78 €	540,00 €
					3000 K	2750 lm	LE015720	453,78 €	540,00 €
					1800–3000 K D2W	2180 lm	LE015721	491,60 €	585,00 €
	<b>Tube Leuchteinheit M</b> Tube lighting unit M	LED	TRIAC	27 W	2700 K	2610 lm	LE015722	382,35 €	455,00 €
					3000 K	2750 lm	LE015723	382,35 €	455,00 €
					1800–3000 K D2W	2180 lm	LE015724	420,17 €	500,00 €
			DALI	27 W	2700 K	2610 lm	LE015725	411,76 €	490,00 €
					3000 K	2750 lm	LE015726	411,76 €	490,00 €
					1800–3000 K D2W	2180 lm	LE015727	449,58 €	535,00 €
	<b>Glas M long mit Reflektor</b> glass M long with reflector						DU015803	222,69 €	265,00 €
	<b>Glas M short mit Reflektor</b> glass M short with reflector						DU015804	172,27 €	205,00 €

## DRUM Suspension S/M – Zubehör / Accessories

**Baldachinprofile** Baldachine für die Montage von zwei oder drei DRUM Suspension an nur einem Deckenauslass finden Sie auf Seiten 198–199.  
Canopy profiles Canopies for mounting two or three DRUM Suspension on only one ceiling outlet can be found on pages 198–199.

# ONE EIGHTY Suspension

Als Pendelversion besonders geeignet auch zur Reihung mehrerer Leuchten, wirkt ONE EIGHTY Suspension unaufdringlich elegant. Mit zwei Schirmgrößen und zahlreichen Varianten, wahlweise mit einstellbarer Festlänge oder bequemer Höhenverstellung (Adjustable) kann jede Situation perfekt ausgeleuchtet werden.

Also particularly suitable for lining up rows of lamps, as a suspended version ONE EIGHTY Suspension makes an unobtrusive, elegant impression. With two shade sizes and numerous versions, available with optional set length or easy height adjustment, every situation can be lit perfectly.

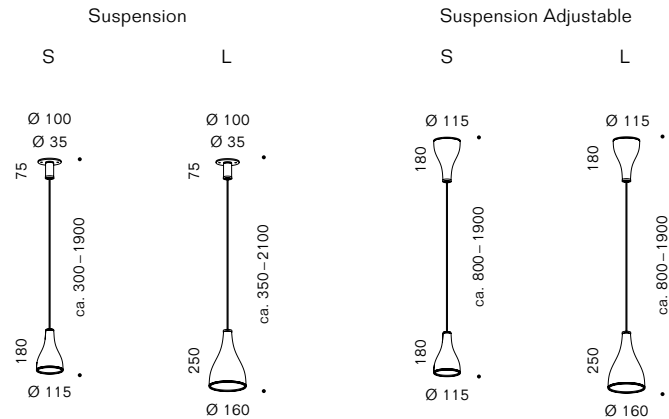



**Licht**  
light **nach vorne gerichtet, seitlich abgeschirmt**  
directed forward, shielded to the sides

**Leuchtmittel**  
lamp **S: GU10, L: E27 (Lieferung ohne Leuchtmittel)**  
S: GU10, L: E27 (delivery without bulb)



**Baldachin & Schirm**  
canopy & shade **Aluminium gebürstet, weiß oder schwarz lackiert; Zierringe: Stahl vernickelt**  
brushed aluminium with protective coating, coated white or black; decorative rings: steel nickel plated





## ONE EIGHTY Suspension S

Abbildung figure	Beschreibung description	Fassung socket	Regelung control	Leistung power	Art.-Nr. art.-no.	€ netto DE excl. VAT	€ brutto DE incl. VAT
	<b>gebürstet</b> brushed	GU10	TRIAC	max. 60	OE1001	336,13 €	400,00 €
	<b>schwarz</b> black	GU10	TRIAC	max. 60	OE1021	336,13 €	400,00 €
	<b>weiß</b> white	GU10	TRIAC	max. 60	OE1003	336,13 €	400,00 €



## ONE EIGHTY Suspension Adjustable S

Abbildung figure	Beschreibung description	Fassung socket	Regelung control	Leistung power	Art.-Nr. art.-no.	€ netto DE excl. VAT	€ brutto DE incl. VAT
	<b>gebürstet</b> brushed	GU10	TRIAC	max. 60	OE1002	420,17 €	500,00 €
	<b>schwarz</b> black	GU10	TRIAC	max. 60	OE1022	420,17 €	500,00 €
	<b>weiß</b> white	GU10	TRIAC	max. 60	OE1004	420,17 €	500,00 €

## ONE EIGHTY Suspension L

Abbildung figure	Beschreibung description	Fassung socket	Regelung control	Leistung power	Art.-Nr. art.-no.	€ netto DE excl. VAT	€ brutto DE incl. VAT
	<b>gebürstet</b> brushed	E27	TRIAC	max. 100	OE1005	378,15 €	450,00 €
	<b>schwarz</b> black	E27	TRIAC	max. 100	OE1023	378,15 €	450,00 €
	<b>weiß</b> white	E27	TRIAC	max. 100	OE1007	378,15 €	450,00 €

## ONE EIGHTY Suspension Adjustable L

Abbildung figure	Beschreibung description	Fassung socket	Regelung control	Leistung power	Art.-Nr. art.-no.	€ netto DE excl. VAT	€ brutto DE incl. VAT
	<b>gebürstet</b> brushed	E27	TRIAC	max. 100	OE1006	478,99 €	570,00 €
	<b>schwarz</b> black	E27	TRIAC	max. 100	OE1024	478,99 €	570,00 €
	<b>weiß</b> white	E27	TRIAC	max. 100	OE1008	478,99 €	570,00 €

## POPPY Suspension

Werden die „Mohnblüten“ dieser Familie durch Einschalten geweckt, öffnen sich ihre Schirme ganz allmählich: die feinen Blätter sind aus Bimetall und dehnen sich durch Erwärmung aus. Alle Varianten können nach Belieben umgestaltet werden. Der flexible, textilmantelte Schlauch lässt sich immer neu biegen – zur Änderung der Lichtrichtung, oder einfach weil Ihnen danach ist. Die mundgeblasenen Glaskapseln sind erhältlich in den Farben keramik, rubinrot oder violett.

When the “poppy flowers” in this family are woken by the lamp being switched on, their shades open very gradually: the delicate leaves are bi-metallic and expand when heated. All the versions can be reshaped as desired. The flexible, textile-coated stem can be bent at will, to change the direction of the light, or because you just feel like it. The hand-blown glass capsules are available in ceramic, ruby red or violet.

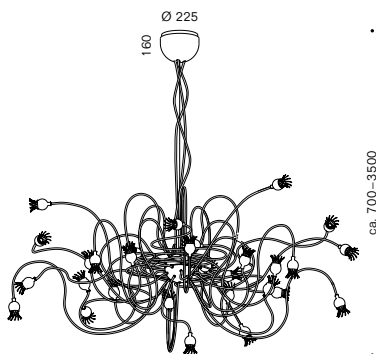

**Licht**  
light **nach vorne gerichtet, rundum dekorativ**  
directed forward, decorative all around

**Leuchtmittel**  
lamp **30 × G4 20 W, 12 V, EEK/EEC G**

**Material**  
material **30 Arme, flexibel: Aluminium, textilmantelt beige oder schwarz, Länge 150 cm; Glasschirme: mundgeblasenes Glas in keramik, rubinrot oder violett; Lamellen: Bimetall. Baldachin: Edelstahl gebürstet**  
30 arms, flexible: textile coated aluminium tube in beige or black; length 150 cm  
glass shade: hand-blown glass in ceramic, ruby red or violet; lamellae: bimetal; canopy: stainless steel, polished

**Sonstiges**  
features **Leuchtmittel in Lieferung enthalten; Reflektor-Lamellen öffnen sich nach ca. 2 Minuten Betriebszeit**  
lamps included in delivery; lamellae open within approx. 2 minutes after switching on luminaire

## POPPY Suspension

Abbildung figure	Beschreibung description	Fassung socket	Regelung control	Leistung power	Art.-Nr. art.-no.	€ netto DE excl. VAT	€ brutto DE incl. VAT
	<b>30 Arme schwarz, Schirme keramik</b> 30 arms black, shades ceramic	30 × G4	ON/OFF	max. 600 W	PO1004	4.369,75 €	5.200,00 €
	<b>30 Arme schwarz, Schirme rubinrot</b> 30 arms black, shades red	30 × G4	ON/OFF	max. 600 W	PO1005	4.369,75 €	5.200,00 €
	<b>30 Arme schwarz, Schirme violett</b> 30 arms black, shades violet	30 × G4	ON/OFF	max. 600 W	PO1006	4.369,75 €	5.200,00 €
	<b>30 Arme beige, Schirme keramik</b> 30 arms beige shades ceramic	30 × G4	ON/OFF	max. 600 W	PO1019	4.369,75 €	5.200,00 €
	<b>30 Arme beige, Schirme rubinrot</b> 30 arms beige shades red	30 × G4	ON/OFF	max. 600 W	PO1020	4.369,75 €	5.200,00 €
	<b>30 Arme beige, Schirme violett</b> 30 arms beige shades violet	30 × G4	ON/OFF	max. 600 W	PO1021	4.369,75 €	5.200,00 €

## PROPELLER Suspension

Dieser wunderbar zarte Entwurf ist ein überaus effizienter, geräuschloser Ventilator und zentrale Deckenbeleuchtung zugleich. Über ein filigranes Federdrahtgestell wird einfach ein (waschbares) elastisches Gewebe gezogen. Von innen beleuchtet, entsteht eine ebenso reizvolle wie nützliche animierte Skulptur. Und mit einer Funk-Fernbedienung regeln Sie die Drehzahl und die Drehrichtung – bequem von Ihrem Lieblingsplatz aus.

This wonderfully delicate design is an extremely efficient, silent fan and main ceiling lighting at one and the same time. A (washable) elastic fabric is just pulled over a filigree spring wire frame. Illuminated from inside, an animated sculpture emerges that is as charming as it is useful. And with a remote control you can easily regulate the number of revolutions and the direction of rotation from your favorite spot.

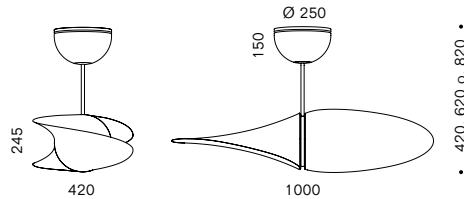

Licht light	gestreut durch den Stoffüberzug diffused through fabric cover
Leuchtmittel lamp	E27, nicht dimmbar, max. 105 W; Lieferung ohne Leuchtmittel E27, not dimmable, max. 105 W; delivery without bulb
Material material	<b>Baldachin und Rohr: Aluminium gebürstet;</b> <b>Flügel: Stoffüberzug weiß aus 80% Polyamid und 20% Elasthan gespannt über Federstahl</b> canopy and tube: aluminium brushed; wings: fabric cover white made of 80% polyamide and 20% elastane stretched over spring wire steel
Sonstiges features	<b>Fernbedienung; Licht: An/Aus/nicht dimmbar, kompatibel mit LED-Lampen und steuerbaren LED-Lampen;</b> <b>Motor: Ein/Aus/Vor- bzw. Rückwärtslauf; variable Rotationsgeschwindigkeit</b> <b>(6-stufig mit Memory-Funktion, 25 U/Min (4 W) bis 140 U/Min.(16 W)</b> Remote control; light: on/off/ not dimmable, compatible with LED lamps and controllable LED lamps; Motor: on/off/forward or reverse; variable rotational speed (6-stage speed control with memory function, from approx. 25 RPM (4 W) up to 140 RPM (16 W)

## PROPELLER Suspension

Abbildung figure	Beschreibung description	Fassung socket	Regelung control	Leistung power	Art.-Nr. art.-no.	€ netto DE excl. VAT	€ brutto DE incl. VAT
	<b>Länge 420 mm</b> length 420 mm	E27	ON/OFF	max. 105 W	PR2101	1.075,63 €	1.280,00 €
	<b>Länge 620 mm</b> length 620 mm	E27	ON/OFF	max. 105 W	PR2102	1.075,63 €	1.280,00 €
	<b>Länge 820 mm</b> length 820 mm	E27	ON/OFF	max. 105 W	PR2103	1.075,63 €	1.280,00 €



## REEF Suspension

Die unverwechselbaren Leuchtschirme dieser Familie bestehen aus innovativer Schaumkeramik, deren Struktur stark an Korallen erinnert. Dabei sind sie durabel, spülmaschinentauglich und verteilen das Streulicht perfekt in einem sanften Bone China-Farbtönen. Die zylindrischen Körper sind einseitig offen – so strahlen die Leuchten dieser Familie kräftig und brillant, aber völlig blendfrei.

The unmistakable lamp shades in this family are made of innovative foam ceramic, whose texture is highly reminiscent of corals. That said they are durable, dishwasher-proof and distribute the scattered light perfectly in a gentle bone china hue. The cylindrical objects are open on one side, such that the lamps in this family shine powerfully and brightly, though without any glare at all.

DESIGN PLUS



Internationaler Designpreis Baden-Württemberg 2003



reddot design award winner 2004

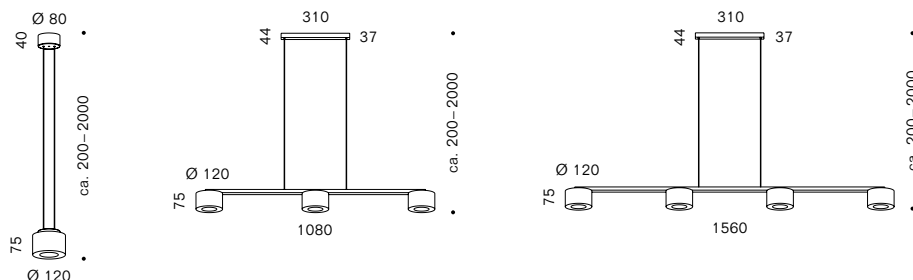

**Licht**  
light **nach unten gerichtet, rundum diffus**  
directed downwards, diffuse all around

**Leuchtmittel**  
lamp **LED 1 x, 3 x, 4 x 8 W, CoB, CRI Ra>90, EEK/EEC F**  
1 x, 3 x, 4 x G9 20 W, EEK/EEC G

**Gehäuse**  
Housing **Aluminium poliert oder gebürstet; Schirm: Keramikschaum weiß**  
aluminium polished or brushed; shade: ceramic foam white

**Sonstiges**  
features **LED austauschbar; Schirm werkzeuglos abnehmbar und spülmaschinenfest**  
LED exchangeable; shade tool-free removable and dishwasher safe

## REEF Suspension 1

Abbildung figure	Beschreibung description	Leuchtmittel lamp	Regelung control	Leistung power	CCT	Lumen lumen	Art.-Nr. art.-no.	€ netto DE excl. VAT	€ brutto DE incl. VAT
●	<b>gebürstet</b> brushed	LED	TRIAC	8 W	2700 K	660 lm	RF2018	373,95 €	445,00 €
●	<b>poliert</b> polished	LED	TRIAC	8 W	2700 K	660 lm	RF2017	373,95 €	445,00 €

## REEF Suspension 3

Abbildung figure	Beschreibung description	Leuchtmittel lamp	Regelung control	Leistung power	CCT	Lumen lumen	Art.-Nr. art.-no.	€ netto DE excl. VAT	€ brutto DE incl. VAT
●	<b>gebürstet</b> brushed	LED	TRIAC	26 W	2700 K	2820 lm	RF2021	1.134,45 €	1.350,00 €
		3 x G9	TRIAC	max. 180 W	2700 K	2940 lm	RF1006	890,76 €	1.060,00 €

## REEF Suspension 4

Abbildung figure	Beschreibung description	Leuchtmittel lamp	Regelung control	Leistung power	CCT	Lumen lumen	Art.-Nr. art.-no.	€ netto DE excl. VAT	€ brutto DE incl. VAT
●	<b>gebürstet</b> brushed	LED	TRIAC	38 W	2700 K	3760 lm	RF2031	1.302,52 €	1.550,00 €
		4 x G9	TRIAC	max. 240 W	2700 K	3020 lm	RF1008	991,60 €	1.180,00 €

## REEF Suspension 1 – Zubehör / Accessories

**Baldachinprofile** **Baldachine für die Montage von zwei oder drei REEF Suspension 1 an nur einem Deckenauslass finden Sie auf Seiten 198–199.**  
Canopy profiles Canopies for mounting two or three REEF Suspension 1 on only one ceiling outlet can be found on pages 198–199.

☞ → 94 REEF Ceiling → 11 | REEF Wall → 115 | Baldachinprofile/Canopy profiles → 198–199

# TWIN

Der Aufbau dieser eleganten Pendelleuchte ist einfach und transparent, ohne nüchtern zu wirken und verweist auf ihr Funktionsprinzip. Um den Abstand der Zwillingschirme zu verstellen, werden die Leuchtenarme einfach und leichtgängig auseinander gezogen und so den jeweiligen Bedürfnissen angepasst. Unabhängig vom Winkel der Arme bleiben die Schirme dabei stets waagrecht. Ist TWIN ganz ausgezogen, eröffnet sich zwischen den Schirmen ein Raum, der wunderbar genutzt werden kann – zum Beispiel für größere Vasen und Blumengestecke auf dem Tisch.

DESIGN PLUS



The structure of this elegant suspended lamp is straightforward and transparent, without seeming sober, and highlights its function. To alter the distance between the two shades, the arms of the lamp are simply pulled apart and thus adapted to the relevant needs. Regardless of the angle of the arms the shades stay horizontal at all times. If TWIN is fully expanded a space opens up between the two shades that can be put to optimum use, for example for large vases and bouquets on the table top.

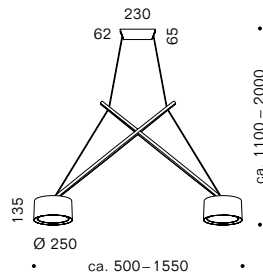

<b>Licht</b> light	<b>direkt nach unten, rundum diffus</b> directed downwards, diffuse all around
<b>Leuchtmittel</b> lamp	LED 2 x 11,5 W, CoB, CRI Ra>97 (R9>80), EEK/EEC F (2700 K), E (3000 K) 2 x 60 W, 2 x G9, EEK/EEC G
<b>Material</b> material	<b>Leuchtenarme und Baldachin: Aluminium glanzverchromt oder schwarz seidenmatt lackiert;</b> <b>Schirme: Acrylglas opal weiß oder mundgeblasenes Glas opal weiß; Kabel: textillummantelt, schwarz</b> arms and canopy: Aluminium bright chrome-plated or black lacquered; shades: Acrylic glass opal white or hand-blown translucent genuine glass; cable: textile coated black
<b>Sonstiges</b> features	<b>LED wechselbar; Schirmabstand über Scherengitterprinzip stufenlos verstellbar;</b> <b>geeignet bis Deckenhöhe ca 3,3 m (weitere Kabellängen auf Anfrage) und Tischlängen bis 3,3 m</b> LED exchangeable; shade spacing can be set as desired due to its snake fence structure; suitable for ceiling heights up to 3.3 m (other lengths on request) and tables up to 3.3 m long

## TWIN Suspension

Abbildung figure	Beschreibung description	Leuchtmittel lamp	Regelung control	Leistung power	CCT	Lumen lumen	Art.-Nr. art.-no.	€ netto DE excl. VAT	€ brutto DE incl. VAT
●	<b>schwarz, Acrylglas opal</b> black, acrylic glass opal	LED	TRIAC	23 W	2700 K	2240 lm	TW1103	1.210,08 €	1.440,00 €
					3000 K	2360 lm	TW1107	1.210,08 €	1.440,00 €
		2 x G9	TRIAC	max. 120 W	2800 K	1960 lm	TW1003	899,16 €	1.070,00 €
●	<b>schwarz, Glas opal</b> black, glass opal	LED	TRIAC	23 W	2700 K	2240 lm	TW1303	1.420,17 €	1.690,00 €
					3000 K	2360 lm	TW1307	1.420,17 €	1.690,00 €
		2 x G9	TRIAC	max. 120 W	2800 K	1960 lm	TW1203	1.084,03 €	1.290,00 €
●	<b>glanzverchromt, Acrylglas opal</b> chrome-plated, acrylic glass opal	LED	TRIAC	23 W	2700 K	2240 lm	TW1101	1.302,52 €	1.550,00 €
					3000 K	2360 lm	TW1105	1.302,52 €	1.550,00 €
		2 x G9	TRIAC	max. 120 W	2800 K	1960 lm	TW1001	991,60 €	1.180,00 €
●	<b>glanzverchromt, Glas opal</b> chrome-plated, glass opal	LED	TRIAC	23 W	2700 K	2240 lm	TW1301	1.504,20 €	1.790,00 €
					3000 K	2360 lm	TW1305	1.504,20 €	1.790,00 €
		2 x G9	TRIAC	max. 120 W	2800 K	1960 lm	TW1201	1.168,07 €	1.390,00 €

# ZOOM, ZOOM XL

Wenn man ein flexibles Scherengitter zum Kreis schließt, kann dieser seinen Durchmesser ändern – ein Effekt, den man am ehesten mit einem Kamera-ZOOM beschreiben kann. In Größe und Gestalt durchaus ein moderner Kronleuchter, wirkt ZOOM besonders imposant in den Versionen mit zwei oder drei Leuchtringen, die individuell gestuft werden können. Und für den ganz großen Auftritt gibt es ZOOM XL mit einem maximalen Durchmesser von 2.60 Metern.

If you form a circle with a flexible concertina mesh, the latter's diameter can change, an effect that can best be described with a camera zoom. In terms of size and shape by all means a modern-day chandelier, ZOOM is particularly impressive in the versions with two or three rings of lights, which can be individually layered. And for that big occasion there is ZOOM XL, which has a maximum diameter of 2.60 meters.

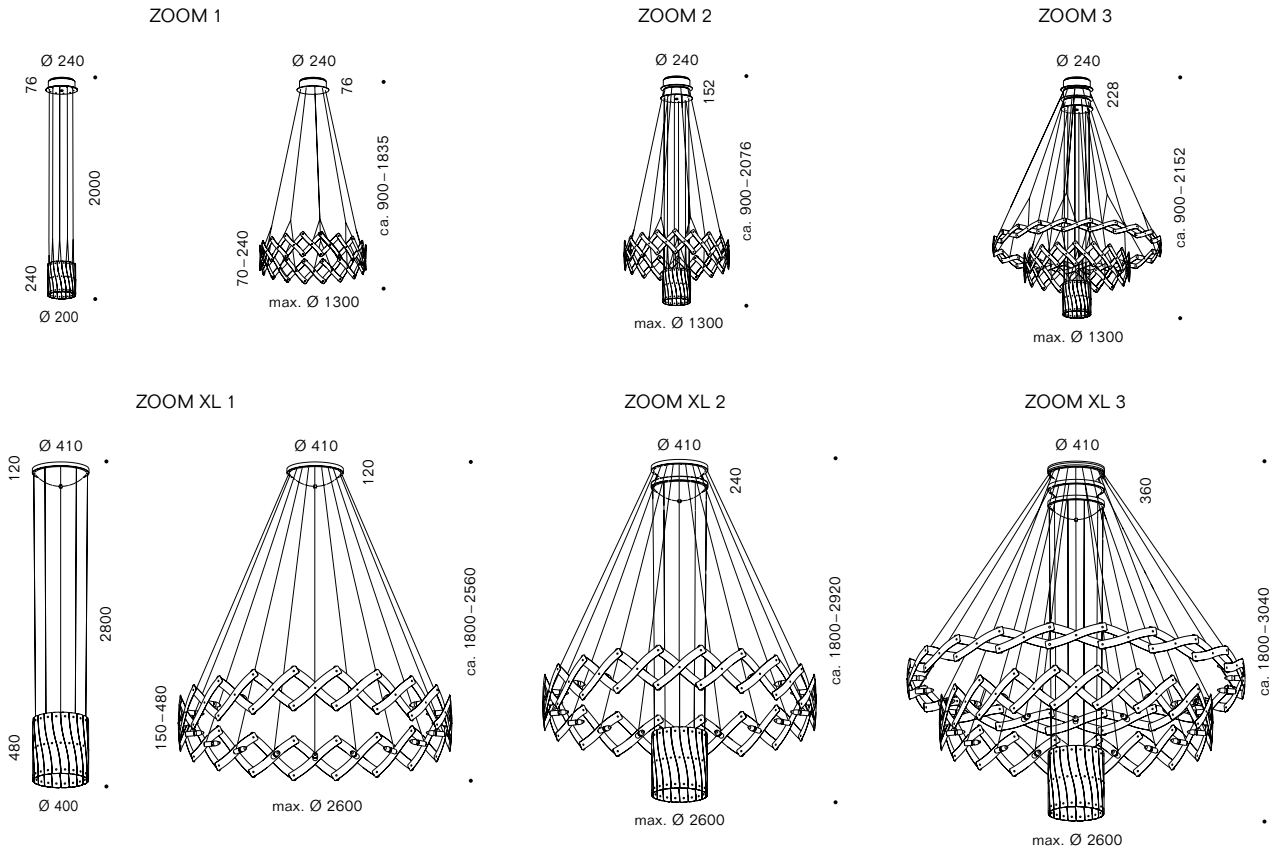

<b>Licht</b> light	<b>frei abstrahlend, diffus durch Lamellen</b> free radiating, diffused through lamellae		
<b>Leuchtmittel</b> lamp	<b>ZOOM 1</b> LED 20 × 1,5 W, CRI Ra>90, EEK/EEC F G4 20 × 10 W, EEK/EEC G  <b>ZOOM XL 1</b> 20 × E14 ohne Leuchtmittel/without bulbs	<b>ZOOM 2</b> LED 40 × 1,5 W, CRI Ra>90, EEK/EEC F G4 40 × 10 W, EEK/EEC G  <b>ZOOM XL 2</b> 40 × E14 ohne Leuchtmittel/without bulbs	<b>ZOOM 3</b> LED 60 × 1,5 W CRI Ra>90, EEK/EEC F G4 60 × 10 W, EEK/EEC G  <b>ZOOM XL 3</b> 60 × E14 ohne Leuchtmittel/without bulbs
<b>Gehäuse</b> Housing	<b>Baldachin: Edelstahl gebürstet; Lamellen Edelstahl gebürstet, transluzente weiße Folie</b> canopy: brushed stainless steel; lamellae: brushed stainless steel, translucent foil		
<b>Sonstiges</b> features	<b>Durchmesser über Scherengitterprinzip stufenlos verstellbar. Für maximalen Durchmesser beträgt die Mindestabhängung 900 mm, bei geschlossener Leuchte. Die Leuchte steigt durch völliges Öffnen um 350 mm. Optional erhältlich: ZOOM Kristallglas Anhänger. Funkelnde Kristallketten aus Bleikristallglas die einfach in die unteren Scherengitterdrehpunkte eingehängt werden. LED und Halogen Leuchtmittel austauschbar.</b> Diameter continuously adjustable. For maximum diameter minimum suspension is 900 mm when lamp closed. Lamp will rise 350 mm when completely opened. Optional available: ZOOM crystal glass pendants. Sparkling crystal chains of lead crystal glass which are hooked into the lower scissor lattice pivot points. LED and halogen bulbs exchangeable.		

## ZOOM 1

Abbildung figure	Beschreibung description	Leuchtmittel lamp	Regelung control	Leistung power	CCT	Lumen lumen	Art.-Nr. art.-no.	€ netto DE excl. VAT	€ brutto DE incl. VAT
●	gebürstet brushed	LED	TRIAC	35 W	2700 K	2700 lm	ZO3001	1.252,10 €	1.490,00 €
			DALI	35 W	2700 K	2580 lm	ZO3011	1.336,13 €	1.590,00 €
		20 × G4	TRIAC	max. 200 W	2700 K	2600 lm	ZO1001	882,35 €	1.050,00 €

## ZOOM 2

Abbildung figure	Beschreibung description	Leuchtmittel lamp	Regelung control	Leistung power	CCT	Lumen lumen	Art.-Nr. art.-no.	€ netto DE excl. VAT	€ brutto DE incl. VAT
●	gebürstet brushed	LED	TRIAC	70 W	2700 K	5400 lm	ZO3002	2.436,97 €	2.900,00 €
			DALI	70 W	2700 K	5160 lm	ZO3012	2.605,04 €	3.100,00 €
		40 × G4	TRIAC	max. 400 W	2700 K	5200 lm	ZO1003	1.680,67 €	2.000,00 €

## ZOOM 3

Abbildung figure	Beschreibung description	Leuchtmittel lamp	Regelung control	Leistung power	CCT	Lumen lumen	Art.-Nr. art.-no.	€ netto DE excl. VAT	€ brutto DE incl. VAT
●	gebürstet brushed	LED	TRIAC	105 W	2700 K	8100 lm	ZO3003	3.613,45 €	4.300,00 €
			DALI	105 W	2700 K	7740 lm	ZO3013	3.865,55 €	4.600,00 €
		60 × G4	TRIAC	max. 600 W	2700 K	7800 lm	ZO1006	2.436,97 €	2.900,00 €

## ZOOM XL 1

Abbildung figure	Beschreibung description	Fassung socket	Regelung control	Leistung power	Art.-Nr. art.-no.	€ netto DE excl. VAT	€ brutto DE incl. VAT
●	gebürstet brushed	20 × E14	TRIAC	max. 560 W	ZO1002	2.605,04 €	3.100,00 €

## ZOOM XL 2

Abbildung figure	Beschreibung description	Fassung socket	Regelung control	Leistung power	Art.-Nr. art.-no.	€ netto DE excl. VAT	€ brutto DE incl. VAT
●	gebürstet brushed	40 × E14	TRIAC	max. 1120 W	ZO1004	5.126,05 €	6.100,00 €

## ZOOM XL 3

Abbildung figure	Beschreibung description	Fassung socket	Regelung control	Leistung power	Art.-Nr. art.-no.	€ netto DE excl. VAT	€ brutto DE incl. VAT
●	gebürstet brushed	60 × E14	TRIAC	max. 1680 W	ZO1005	7.647,06 €	9.100,00 €









CAVITY Suspension • aluminium gloss finish

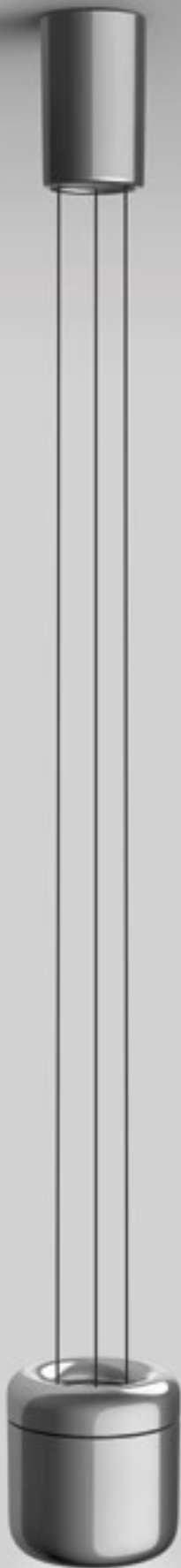

CAVITY Suspension • white



SUSPENSION

CAVITY Suspension • black



CAVITY Suspension • bronze finish











**CURLING Suspension Tube M • glass new silver**



**CURLING Suspension Rope M • glass clear**



SUSPENSION

**CURLING Suspension Rope M • glass clear  
reflector: conical**



**CURLING Suspension Rope M • glass clear  
reflector: cylindrical**





clear



blue



brown









Rope S · long



Rope S · short



Rope M · long



Rope M · short









white



90

silver



black





SUSPENSION











TWIN • chrome-plated



SUSPENSION

















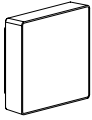

**APP**  
S. 102



**CAVITY**  
S. 105



**CLUB**  
S. 106



**CRIB**  
S. 107

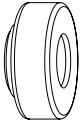

**CURLING**  
S. 108

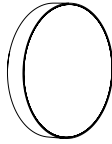

**LID**  
S. 110

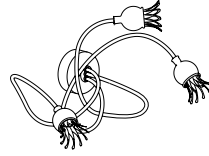

**POPPY**  
S. 112



**REEF**  
S. 115



**REFLEX<sup>2</sup>**  
S. 116

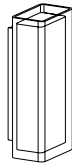

**ROD**  
S. 117



**SML**  
S. 118



**SML<sup>2</sup>**  
S. 120



## APP Wall

**Kluges Licht, kreative Vielfalt! Ein formal schlichter LED-Leuchtquader zeigt, was in ihm steckt. Mit seiner doppellagigen Frontfläche eröffnet er größten Gestaltungsspielraum. Allein die Bandbreite der verfügbaren Standard-Fronten reicht von unterschiedlichen Strukturoberflächen über sanft mattierte Farben bis hin zu Spiegelflächen und solchen mit optischen Effekten. Wer ein Statement setzen oder eine Botschaft transportieren möchte, lässt APP mit individuellen Prints personalisieren. Hinweise, Zimmernummern, Firmenfarben... Sie haben die Wahl.**



Intelligent light, creative diversity! A formally reduced LED cube shows the power within. With its double-layered front surface APP opens up immense creative scope. Even the range of standard fronts available allows numerous options from different textured structures to restrained satin colors to mirrored surfaces and those with visual effects. Those who want to make a statement or transport a message can have App personalized with individual prints. Notes, room numbers, corporate colors... it's up to you!

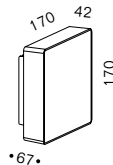

**Licht**  
light **nach oben und unten streuend, seitlich diffus**  
up- and downwards dispersed, diffuse to the sides

**Leuchtmittel**  
lamp LED 16–22 W, CRI Ra>90, EEK/EEC E











**Leuchteneinheit**  
light unit **Kühlkörper: Aluminium; Schirm: Polycarbonat klar**  
heatsink: aluminium; shade: polycarbonate clear

**Front**  
front **Plexiglas®, Echtglas**  
Plexiglas®, genuine glass



**Sonstiges**  
features **LED austauschbar; Fronten als Sonderausführungen in allen gängigen Plexiglas 3 mm Platten und als Foliendruck möglich; IP44 und 110 V-Varianten auf Anfrage; DALI-Varianten sind geeignet für den Einsatz in Notbeleuchtungsanlagen**  
LED exchangeable; Fronts available in special versions in all common Plexiglas 3 mm panels and with foil printing; IP44 and 110 V-version on request; DALI versions are suitable for the use in emergency lighting systems

# APP Wall

Abbildung figure	Beschreibung description	Leuchtmittel lamp	Regelung control	Leistung power	CCT	Lumen lumen	Art.-Nr. art.-no.	€ netto DE excl. VAT	€ brutto DE incl. VAT
	<b>Leuchteinheit APP</b> lighting unit APP	LED	TRIAC	16 W	2700 K	1880 lm	AP1001	281,51 €	335,00 €
					3000 K	1880 lm	AP1002	281,51 €	335,00 €
			DALI	22 W	2700 K	2690 lm	AP1005	319,33 €	380,00 €
					3000 K	2690 lm	AP1006	319,33 €	380,00 €
	<b>Front Rippe</b> front ribbed						AP1101	79,83 €	95,00 €
	<b>Front Pyramide</b> front pyramid						AP1102	79,83 €	95,00 €
	<b>Front Wabe</b> front honeycomb						AP1103	79,83 €	95,00 €
	<b>Front Eiskristall</b> front cracked ice						AP1104	79,83 €	95,00 €
	<b>Front Weiß</b> front white						AP1105	79,83 €	95,00 €
	<b>Front Echtglasspiegel</b> front genuine glass mirror						AP1106	100,84 €	120,00 €
	<b>Front Grau</b> front grey						AP1107	79,83 €	95,00 €
	<b>Front fluoreszierend Grün</b> front fluorescent green						AP1108	79,83 €	95,00 €
	<b>Front individueller Foliendruck</b> front individual foil print						AP1199	189,08 €	225,00 €



## CAVITY Wall

CAVITY Wall setzt sanfte Lichtakzente auf der Wand und ergänzt die Produktfamilie um eine gleichseitig nach oben und unten abstrahlende Wandleuchte. Speziell konzipierte, kurvenförmige Aluminiumkörper und das vertieft darin sitzende Leuchtmittel erlauben eine freie Entfaltung des Lichts, das über die Trichterform scheinbar nach außen fließt. Unterschiedliche Beleuchtungsaufgaben können einheitlich durch Kombination der Wandleuchten mit Aufbau- und Einbaustrahlern sowie den Pendelleuchten dieser Produktfamilie gelöst werden.

CAVITY Wall sets gentle light accents on the wall and extends the product family with a wall luminaire distributing light equally upwards and downwards. Specially designed, curved aluminum bodies and the recessed illuminant within allow the light to unfold freely, seemingly flowing outwards via the funnel shaped form. Different lighting tasks can be solved consistently by combining the wall luminaires with surface-mounted and recessed spotlights and the pendant luminaires of this product family.

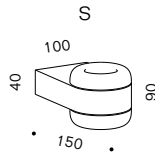

**Licht**  
light **nach oben und unten gerichtet, seitlich abgeschirmt**  
directed upwards and downwards, shielded to the sides

**Leuchtmittel**  
lamp **LED 19 W, CoB, CRI Ra>97 (R9>80), EEK/EEC E**

**Leuchteneinheit**  
lighting unit **Aluminium schwarz oder weiß beschichtet**  
aluminum black or white coated

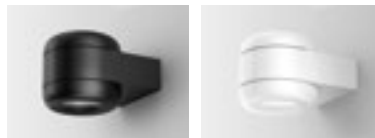

**Sonstiges**  
features **LED austauschbar**  
LED exchangeable

## CAVITY Wall S

Abbildung figure	Beschreibung description	Leuchtmittel lamp	Regelung control	Leistung power	CCT	Lumen lumen	Art.-Nr. art.-no.	€ netto DE excl. VAT	€ brutto DE incl. VAT
●	<b>schwarz</b> black	LED	TRIAC	19 W	2700 K	1790 lm	CA2401	302,52 €	360,00 €
					3000 K	1880 lm	CA2402	302,52 €	360,00 €
			DALI	19 W	2700 K	1790 lm	CA2411	327,73 €	390,00 €
					3000 K	1880 lm	CA2412	327,73 €	390,00 €
○	<b>weiß</b> white	LED	TRIAC	19 W	2700 K	1790 lm	CA2405	302,52 €	360,00 €
					3000 K	1880 lm	CA2406	302,52 €	360,00 €
			DALI	19 W	2700 K	1790 lm	CA2415	327,73 €	390,00 €
					3000 K	1880 lm	CA2416	327,73 €	390,00 €

## CLUB Wall

Diese Familie zeitlos klassischer Schirmleuchten ist für den anspruchsvollen Bedarf optimiert. Statt eines Drahtgestells halten schlanke Aluminiumprofile den Schirm – und vermeiden unschöne Schattenkanten.

This family of timeless classical lamps with shades has been improved to satisfy sophisticated demands. Instead of a wire frame, slender aluminum profiles hold shade, avoiding unsightly shadow lines.

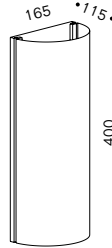

<b>Licht</b> light	<b>nach oben und unten direkt, gerichtet, diffus durch Schirm</b> directly up- and downwards, directional, diffuse through shade
<b>Leuchtmittel</b> lamp	LED R7s 15 W, CRI Ra>80 EEK/EEC E
<b>Material</b> material	<b>Aluminium gebürstet oder schwarz lackiert; Schirm: Chintz weiß oder Melange grau</b> aluminium brushed or black coated; shade: chintz white or melange grey
<b>Sonstiges</b> features	<b>LED-Retrofit in Lieferung enthalten</b> LED-Retrofit Included in delivery

## CLUB Wall

Abbildung figure	Beschreibung description	Leuchtmittel lamp	Regelung control	Leistung power	CCT	Lumen lumen	Art.-Nr. art.-no.	€ netto DE excl. VAT	€ brutto DE incl. VAT
	<b>gebürstet, Chintz weiß</b> brushed, Chintz white	LED	TRIAC	15 W	2700 K	2000 lm	CL1075	243,70 €	290,00 €
	<b>schwarz, Chintz weiß</b> black, Chintz white	LED	TRIAC	15 W	2700 K	2000 lm	CL1065	243,70 €	290,00 €
	<b>gebürstet, Melange grau</b> brushed, Melange grey	LED	TRIAC	15 W	2700 K	2000 lm	CL2131	243,70 €	290,00 €
	<b>schwarz, Melange grau</b> black, Melange grey	LED	TRIAC	15 W	2700 K	2000 lm	CL2132	243,70 €	290,00 €

## CRIB Wall

Im ausgeschalteten Zustand ist CRIB ein formal extrem reduziertes Wandobjekt aus einem schlichten Metallkörper und einer transparenten Glasfläche. Erst im eingeschalteten Zustand offenbart sich die Raffinesse des Glaselements, über dessen polierte Kante das LED-Licht eingespeist wird: Eine feine, speziell behandelte Echtglasscheibe lenkt das Licht gleichmäßig nach oben und unten. CRIB kann umgedreht, horizontal oder vertikal montiert werden und sorgt als Solitär oder in der Reihung für eine magische Lichtwirkung in minimalistischer Form.



When switched off, CRIB is a formally extremely reduced wall object made up of a simple metal body and a transparent glass surface. It is only when switched on that the sophistication of the glass element is revealed, as LED light is supplied via its polished edge: A delicate, specially treated pane of glass distributes the light evenly upwards and downwards. CRIB may be installed upside down, vertically or horizontally, and with its minimalist form creates a magical light effect both when used as a single luminaire or in a row.

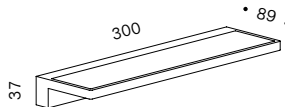

<b>Licht</b> light	<b>nach oben und unten gestreut</b> upwards and downwards diffuse
<b>Leuchtmittel</b> lamp	LED 12 W, CRI Ra>90, R9>50, EEK/EEC E
<b>Material</b> material	<b>Gehäuse: Aluminium schwarz oder weiß beschichtet, Edelstahl finish oder Chrom finish;</b> <b>Lampenabdeckung: Optiwhite Echtglas mit Mikrostruktur</b> housing: aluminium black or white coated, stainless steel finish or chrome finish; lamp cover: optiwhite glass with microstructure
<b>Sonstiges</b> features	<b>LED austauschbar; kann als Up- oder Downlight montiert werden; IP44 Varianten sind nur für Innenräume geeignet</b> LED exchangeable; can be mounted upwards or downwards; IP44 variants are only suitable for indoor use

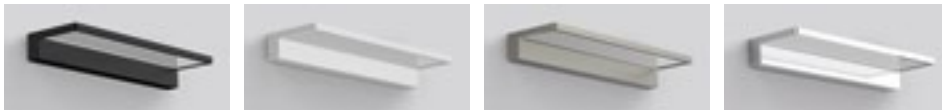

## CRIB Wall

Abbildung figure	Beschreibung description	Leuchtmittel lamp	Regelung control	Leistung power	CCT	Lumen lumen	Art.-Nr. art.-no.	€ netto DE excl. VAT	€ brutto DE incl. VAT
●	<b>schwarz</b> black	LED	TRIAC	12 W	2700 K	1350 lm	CR1001	369,75 €	440,00 €
○	<b>weiß</b> white	LED	TRIAC	12 W	2700 K	1350 lm	CR1002	369,75 €	440,00 €
●	<b>Edelstahl finish</b> stainless steel finish	LED	TRIAC	12 W	2700 K	1350 lm	CR1003	411,76 €	490,00 €
●	<b>Chrom finish</b> chrome finish	LED	TRIAC	12 W	2700 K	1350 lm	CR1005	411,76 €	490,00 €

## CRIB Wall IP44

Abbildung figure	Beschreibung description	Leuchtmittel lamp	Regelung control	Leistung power	CCT	Lumen lumen	Art.-Nr. art.-no.	€ netto DE excl. VAT	€ brutto DE incl. VAT
●	<b>schwarz</b> black	LED	TRIAC	12 W	2700 K	1350 lm	CR1101	403,36 €	480,00 €
○	<b>weiß</b> white	LED	TRIAC	12 W	2700 K	1350 lm	CR1102	403,36 €	480,00 €
●	<b>Edelstahl finish</b> stainless steel finish	LED	TRIAC	12 W	2700 K	1350 lm	CR1103	453,78 €	540,00 €
●	<b>Chrom finish</b> chrome finish	LED	TRIAC	12 W	2700 K	1350 lm	CR1104	453,78 €	540,00 €



## CURLING Wall

CURLING Wall ergänzt die Produktfamilie um eine Wandleuchte, die für ein atmosphärisches Rundumlicht sorgt und so zum prägnanten Lichtobjekt wird. Ein spezieller Diffusor erzeugt ein dekoratives Lichtspiel der mundgeblasenen Glas- und handpolierten Metalloberflächen und macht die Leuchte zugleich blendfrei. Versionen mit Acrylglasschirm in kantiger Ästhetik erweitert das Einsatzspektrum von CURLING und ermöglichen einen optimalen Einsatz in Schulen, Kindergärten, Treppenhäusern und anderen Verkehrswegen im halböffentlichen oder öffentlichen Raum.

INNOVATIONSPREIS  
ARCHITEKTUR +  
TECHNIK  
2020 AUSZEICHNUNG

CURLING Wall extends the product family to include a wall-mounted luminaire that delivers atmospheric all-round light and thus functions as a striking light sculpture. A special diffuser creates decoratively playful light thanks to the handblown glass and hand-polished metal surfaces, and also ensures the luminaire is glare-free. Versions with acrylic glass shade in angular aesthetics expand CURLING's range of applications and enable optimal use in schools, kindergartens, stairwells and other paths in semi-public and public spaces.

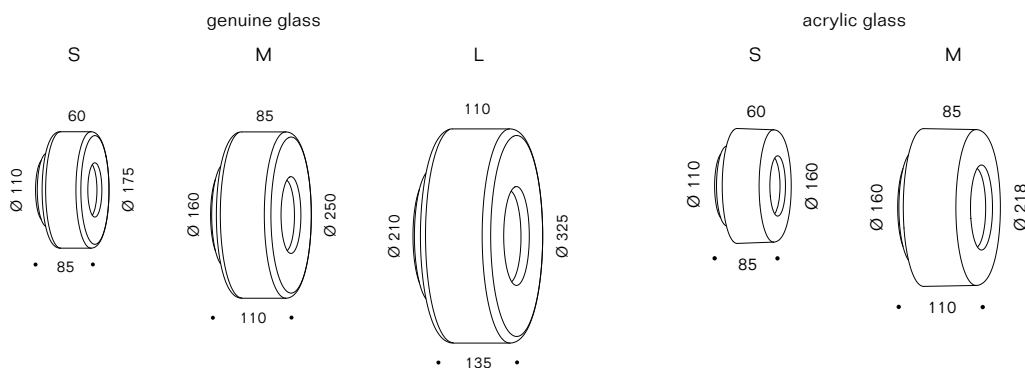

**Leuchtmittel lamp** LED 11–20 W, CoB, CRI Ra>97 (R9>80), EEK/EEC F (2700 K, 3000 K), G (1800–3000 K D2W)

**Leuchteneinheit Lighting unit** Aluminium hochglanzpoliert aluminum highly polished

**Schirm shade** mundgeblasenes Glas klar oder metallisiert  
**Diffusor: Polycarbonat, PMMA**  
hand-blown glass clear or metallised  
diffuser: polycarbonate, PMMA

**Acrylglass klar**  
**Reflektor: Polycarbonat, PMMA**  
Acrylic glass clear  
reflector: polycarbonate, PMMA

**Ausführungen versions**



**Glasschirm klar**  
**Licht: nach vorne diffus, rundum abstrahlend**  
glass shade clear  
light: diffuse to the front, distributed all around



**Acrylglasschirm klar**  
**Licht: nach vorne diffus, rundum abstrahlend**  
acrylic glass shade clear  
light: diffuse to the front, distributed all around







**Glasschirm neusilber**  
**Licht: nach vorne diffus, rundum abstrahlend**  
glass shade new silver  
light: diffuse to the front, distributed all around





**Sonstiges features** LED wechselbar, werkzeuglose Schirmmontage; 110 V-Varianten auf Anfrage;  
DALI-Varianten für den Einsatz in Notbeleuchtungsanlagen auf Anfrage  
LED exchangeable, shade tool-free mountable; 110 V versions on request;  
DALI versions for the use in emergency lighting systems on request

CURLING ist ein modularer Artikel. Bitte jeweils Leuchteneinheit und Glasschirm zusammen bestellen.  
CURLING is a modular article. Please order the lighting unit and glass shade together.



## CURLING Wall S

Abbildung figure	Beschreibung description	Leuchtmittel lamp	Regelung control	Leistung power	CCT	Lumen lumen	Art.-Nr. art.-no.	€ netto DE excl. VAT	€ brutto DE incl. VAT
	<b>Leuchteneinheit S</b> lighting unit S	LED	TRIAC	11 W	2700 K	1130 lm	LE015701	180,67 €	215,00 €
					3000 K	1180 lm	LE015702	180,67 €	215,00 €
					1800 K–3000 K D2W	870 lm	LE015703	214,29 €	255,00 €
			DALI	11 W	2700 K	1130 lm	LE015730	205,88 €	245,00 €
					3000 K	1180 lm	LE015731	205,88 €	245,00 €
					1800 K–3000 K D2W	870 lm	LE015732	239,50 €	285,00 €
	<b>Glas S klar</b> glass S clear						CU011212	201,68 €	240,00 €
	<b>Glas S neusilber</b> glass S new silver						CU011218	281,55 €	335,00 €
	<b>Acrylglas S klar</b> acrylic glass S clear						CU011220	100,84 €	120,00 €

## CURLING Wall M

Abbildung figure	Beschreibung description	Leuchtmittel lamp	Regelung control	Leistung power	CCT	Lumen lumen	Art.-Nr. art.-no.	€ netto DE excl. VAT	€ brutto DE incl. VAT
	<b>Leuchteneinheit M</b> lighting unit M	LED	TRIAC	20 W	2700 K	1910 lm	LE015710	239,50 €	285,00 €
					3000 K	2010 lm	LE015711	239,50 €	285,00 €
					1800 K–3000 K D2W	1540 lm	LE015712	273,11 €	325,00 €
			DALI 1–10 V	20 W	2700 K	1910 lm	LE015713	264,71 €	315,00 €
					3000 K	2010 lm	LE015714	264,71 €	315,00 €
					1800 K–3000 K D2W	1540 lm	LE015715	298,32 €	355,00 €
	<b>Glas M klar</b> glass M clear						CU011209	235,29 €	280,00 €
	<b>Glas M neusilber</b> glass M new silver						CU011219	336,16 €	400,00 €
	<b>Acrylglas M klar</b> acrylic glass M clear						CU011223	126,05 €	150,00 €

## CURLING Wall L

Abbildung figure	Beschreibung description	Leuchtmittel lamp	Regelung control	Leistung power	CCT	Lumen lumen	Art.-Nr. art.-no.	€ netto DE excl. VAT	€ brutto DE incl. VAT
	<b>Leuchteneinheit L</b> lighting unit L	LED	TRIAC	34 W	2700 K	3360 lm	LE014480	289,92 €	345,00 €
					3000 K	3480 lm	LE014483	289,92 €	345,00 €
			DALI	34 W	2700 K	3360 lm	LE014478	315,13 €	375,00 €
					3000 K	3480 lm	LE014481	315,13 €	375,00 €
	<b>Glas L klar</b> glass L clear						CU011210	336,14 €	400,00 €
	<b>Glas L neusilber</b> glass L new silver						CU011224	424,37 €	505,00 €

## CURLING Wall – Zubehör / Accessories

Optiken optics	Einfach austauschbare Optiken zur Bestimmung der Lichtverteilung von CURLING Wall finden Sie auf Seite 201. Easily replaceable optics to define the light distribution of CURLING Wall, see page 201.
-------------------	--

## LID Wall

Bei Tag ist LID ein dezentes Designobjekt. Sobald man LID einschaltet, verwandelt sie sich in sphärisches Licht. Einen besonderen Akzent setzt eine feine Lichtaura, durch die sich die kreisrunde Scheibe von dem sie umgebenden Lichtschein abhebt. LID löst sich optisch vom Hintergrund und entfaltet eine angenehme, ruhige Lichtstimmung.



During the day LID is a discreet design object but as soon as LID is turned on, it morphs into spherical light. The fine aura of light that emanates through the circular disc is particularly eye-catching and sets it off from the surrounding shining light. LID stands out from the backgrounds and contributes to a pleasant, calm and light mood.

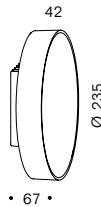

---

<b>Licht</b> light	<b>rundum gleichmäßig abstrahlend</b> radiating evenly right round
-----------------------	---

---

<b>Leuchtmittel</b> lamp	LED 16–22 W, CRI Ra>90, EEK/EEC E
-----------------------------	-----------------------------------

---

<b>Material</b> material	<b>Kühlkörper: Aluminium, Schirm: Plexiglas® transparent;</b> <b>Front: Glas opal, Spiegelglas, Aluminium silber eloxiert, Aluminium champagner eloxiert</b> cooling unit: aluminium; housing: transparent Plexiglas®; front: opal glass, mirror glass, aluminium silver or gold anodized
-----------------------------	--

---







---





<b>Sonstiges</b> features	<b>LED austauschbar</b> LED exchangeable
------------------------------	---

---

## LID Wall

Abbildung figure	Beschreibung description	Leuchtmittel lamp	Regelung control	Leistung power	CCT	Lumen lumen	Art.-Nr. art.-no.	€ netto DE excl. VAT	€ brutto DE incl. VAT
	<b>Leuchteneinheit LID</b> lighting unit LID	LED	TRIAC	16 W	2700 K	1880 lm	LD1001	306,72 €	365,00 €
					3000 K	1880 lm	LD1002	306,72 €	365,00 €
			DALI	22 W	2700 K	2690 lm	LD1005	340,34 €	405,00 €
					3000 K	2690 lm	LD1006	340,34 €	405,00 €
	<b>Front Aluminium champagner eloxiert</b> front aluminium champagne anodized						LD1103	96,64 €	115,00 €
	<b>Front Aluminium silber eloxiert</b> front aluminium silver anodized						LD1104	96,64 €	115,00 €
	<b>Front Echtglas opal</b> front genuine glass opal						LD1101	134,45 €	160,00 €
	<b>Front Spiegel</b> front genuine glass mirror						LD1102	134,45 €	160,00 €

## LID Wall IP44

Abbildung figure	Beschreibung description	Leuchtmittel lamp	Regelung control	Leistung power	CCT	Lumen lumen	Art.-Nr. art.-no.	€ netto DE excl. VAT	€ brutto DE incl. VAT
	<b>Leuchteneinheit LID IP44</b> lighting unit LID IP44	LED	TRIAC	16 W	2700 K	1880 lm	LD1201	340,34 €	405,00 €
					3000 K	1880 lm	LD1202	340,34 €	405,00 €
			DALI	22 W	2700 K	2690 lm	LD1205	365,55 €	435,00 €
					3000 K	2690 lm	LD1206	365,55 €	435,00 €
	<b>IP44 Front Aluminium champagner eloxiert</b> front aluminium champagne anodized						LD1303	117,65 €	140,00 €
	<b>IP44 Front Aluminium silber eloxiert</b> front aluminium silver anodized						LD1304	117,65 €	140,00 €
	<b>IP44 Front Echtglas opal</b> front genuine glass opal						LD1301	151,26 €	180,00 €
	<b>IP44 Front Spiegel</b> front genuine glass mirror						LD1302	151,26 €	180,00 €

## POPPY Wall

Werden die „Mohnblüten“ dieser Familie durch Einschalten geweckt, öffnen sich ihre Schirme ganz allmählich: die feinen Blätter sind aus Bimetall und dehnen sich durch Erwärmung aus. Alle Varianten können nach Belieben umgestaltet werden. Der flexible, textilmantelte Schlauch lässt sich immer neu biegen – zur Änderung der Lichtrichtung, oder einfach weil Ihnen danach ist. Die mundeblasenen Glaskapseln sind erhältlich in den Farben keramik, rubinrot oder violett.

When the “poppy flowers” in this family are woken by the lamp being switched on, their shades open very gradually: the delicate leaves are bi-metallic and expand when heated. All the versions can be reshaped as desired. The flexible, textile-coated stem can be bent at will, to change the direction of the light, or because you just feel like it. The hand-blown glass capsules are available in ceramic, ruby red or violet.

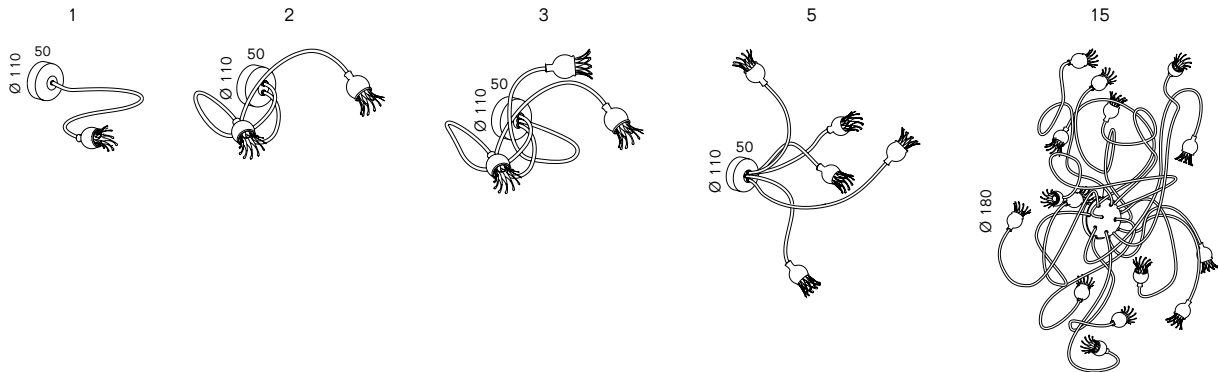







<b>Licht</b> light	<b>nach vorne gerichtet, seitlich abgeschirmt</b> directed forward, shielded to the sides
<b>Leuchtmittel</b> lamp	POPPY Wall 1/2/3: 1×/2×/3×G4 35 W, 12 V, EEK/EEC G POPPY Wall 5/15: 5×/15×G4 20 W, 12 V, EEK/EEC G
<b>Größen</b> sizes	<b>1 bis 5 Arme: Länge der Arme 75 cm, 15 Arme: Länge der Arme 75 oder 150 cm</b> 1 to 5 arms: length of arms 75 cm, 15 arms: length of arms 75 cm or 150 cm
<b>Material</b> material	<b>Arme, flexibel: Aluminium, textilmantelt beige oder schwarz; Glasschirme: mundeblasenes Glas keramik, rubinrot oder violett; Lamellen: Bimetall; Baldachin: 1–5 Arme Edelstahl, poliert; 15 Arme: Edelstahl gebürstet</b> arms, flexible: textile coated aluminium tube in beige or black; glass shade: hand-blown glass in ceramic, ruby red or violet; lamellae: bimetal; canopy: 1–5 arms stainless steel, polished; 15 arms: stainless steel, brushed
<b>Sonstiges</b> features	<b>Leuchtmittel in Lieferung enthalten; Reflektor-Lamellen öffnen sich nach ca. 2 Minuten Betriebszeit; Leuchte kann auch als Deckenleuchte montiert werden</b> lamps included in delivery; lamellae open within approx. 2 minutes after switching on luminaire; luminaire can also be mounted as ceiling luminaire

## POPPY Wall 1







Abbildung figure	Beschreibung description	Fassung socket	Regelung control	Leistung power	Art.-Nr. art.-no.	€ netto DE excl. VAT	€ brutto DE incl. VAT
	<b>1 Arm schwarz, Schirm keramik</b> 1 arm black, shade ceramic	G4	ON/OFF	max. 35 W	PO1025	394,96 €	470,00 €
	<b>1 Arm schwarz, Schirm rubinrot</b> 1 arm black, shade ruby red	G4	ON/OFF	max. 35 W	PO1026	394,96 €	470,00 €
	<b>1 Arm schwarz, Schirm violett</b> 1 arm black, shade violet	G4	ON/OFF	max. 35 W	PO1027	394,96 €	470,00 €
	<b>1 Arm beige, Schirm keramik</b> 1 arm beige shade ceramic	G4	ON/OFF	max. 35 W	PO1028	394,96 €	470,00 €
	<b>1 Arm beige, Schirm rubinrot</b> 1 arm beige shade ruby red	G4	ON/OFF	max. 35 W	PO1029	394,96 €	470,00 €
	<b>1 Arm beige, Schirm violett</b> 1 arm beige shade violet	G4	ON/OFF	max. 35 W	PO1030	394,96 €	470,00 €









## POPPY Wall 2

Abbildung figure	Beschreibung description	Fassung socket	Regelung control	Leistung power	Art.-Nr. art.-no.	€ netto DE excl. VAT	€ brutto DE incl. VAT
	<b>2 Arme schwarz, Schirme keramik</b> 2 arms black, shades ceramic	2 × G4	ON/OFF	max. 70 W	PO1031	495,80 €	590,00 €
	<b>2 Arme schwarz, Schirme rubinrot</b> 2 arms black, shades ruby red	2 × G4	ON/OFF	max. 70 W	PO1032	495,80 €	590,00 €
	<b>2 Arme schwarz, Schirme violett</b> 2 arms black, shades violet	2 × G4	ON/OFF	max. 70 W	PO1033	495,80 €	590,00 €
	<b>2 Arme beige, Schirme keramik</b> 2 arms beige shades ceramic	2 × G4	ON/OFF	max. 70 W	PO1034	495,80 €	590,00 €
	<b>2 Arme beige, Schirme rubinrot</b> 2 arms beige shades ruby red	2 × G4	ON/OFF	max. 70 W	PO1035	495,80 €	590,00 €
	<b>2 Arme beige, Schirme violett</b> 2 arms beige shades violet	2 × G4	ON/OFF	max. 70 W	PO1036	495,80 €	590,00 €







## POPPY Wall 3

Abbildung figure	Beschreibung description	Fassung socket	Regelung control	Leistung power	Art.-Nr. art.-no.	€ netto DE excl. VAT	€ brutto DE incl. VAT
	<b>3 Arme schwarz, Schirme keramik</b> 3 arms black, shades ceramic	3 × G4	ON/OFF	max. 105 W	PO1037	596,64 €	710,00 €
	<b>3 Arme schwarz, Schirme rubinrot</b> 3 arms black, shades ruby red	3 × G4	ON/OFF	max. 105 W	PO1038	596,64 €	710,00 €
	<b>3 Arme schwarz, Schirme violett</b> 3 arms black, shades violet	3 × G4	ON/OFF	max. 105 W	PO1039	596,64 €	710,00 €
	<b>3 Arme beige, Schirme keramik</b> 3 arms beige shades ceramic	3 × G4	ON/OFF	max. 105 W	PO1040	596,64 €	710,00 €
	<b>3 Arme beige, Schirme rubinrot</b> 3 arms beige shades ruby red	3 × G4	ON/OFF	max. 105 W	PO1041	596,64 €	710,00 €
	<b>3 Arme beige, Schirme violett</b> 3 arms beige shades violet	3 × G4	ON/OFF	max. 105 W	PO1042	596,64 €	710,00 €

## POPPY Wall 5

Abbildung figure	Beschreibung description	Fassung socket	Regelung control	Leistung power	Art.-Nr. art.-no.	€ netto DE excl. VAT	€ brutto DE incl. VAT
	<b>5 Arme schwarz, Schirme keramik</b> 5 arms black, shades ceramic	5 × G4	ON/OFF	max. 100 W	PO1043	773,11 €	920,00 €
	<b>5 Arme schwarz, Schirme rubinrot</b> 5 arms black, shades ruby red	5 × G4	ON/OFF	max. 100 W	PO1044	773,11 €	920,00 €
	<b>5 Arme schwarz, Schirme violett</b> 5 arms black, shades violet	5 × G4	ON/OFF	max. 100 W	PO1045	773,11 €	920,00 €
	<b>5 Arme beige, Schirme keramik</b> 5 arms beige shades ceramic	5 × G4	ON/OFF	max. 100 W	PO1046	773,11 €	920,00 €
	<b>5 Arme beige, Schirme rubinrot</b> 5 arms beige shades ruby red	5 × G4	ON/OFF	max. 100 W	PO1047	773,11 €	920,00 €
	<b>5 Arme beige, Schirme violett</b> 5 arms beige shades violet	5 × G4	ON/OFF	max. 100 W	PO1048	773,11 €	920,00 €

## POPPY Wall 15

Abbildung figure	Beschreibung description	Fassung socket	Regelung control	Leistung power	Art.-Nr. art.-no.	€ netto DE excl. VAT	€ brutto DE incl. VAT
	<b>15 Arme 75 cm schwarz, Schirme keramik</b> 15 arms 75 cm black, shades ceramic	15 × G4	ON/OFF	max. 300 W	PO1007	1.764,71 €	2.100,00 €
	<b>15 Arme 150 cm schwarz, Schirme keramik</b> 15 arms 150 cm black, shades ceramic	15 × G4	ON/OFF	max. 300 W	PO1010	1.848,74 €	2.200,00 €
	<b>15 Arme 75 cm schwarz, Schirme rubinrot</b> 15 arms 75 cm black, shades ruby red	15 × G4	ON/OFF	max. 300 W	PO1008	1.764,71 €	2.100,00 €
	<b>15 Arme 150 cm schwarz, Schirme rubinrot</b> arms 150 cm black, shades ruby red	15 × G4	ON/OFF	max. 300 W	PO1011	1.848,74 €	2.200,00 €
	<b>15 Arme 75 cm schwarz, Schirme violett</b> 15 arms 75 cm black, shades violet	15 × G4	ON/OFF	max. 300 W	PO1009	1.764,71 €	2.100,00 €
	<b>15 Arme 150 cm schwarz, Schirme violett</b> 15 arms 150 cm black, shades violet	15 × G4	ON/OFF	max. 300 W	PO1012	1.848,74 €	2.200,00 €
	<b>15 Arme 75 cm beige, Schirme keramik</b> 15 arms 75 cm beige, shades ceramic	15 × G4	ON/OFF	max. 300 W	PO1013	1.764,71 €	2.100,00 €
	<b>15 Arme 150 cm beige, Schirme keramik</b> 15 arms 150 cm beige, shades ceramic	15 × G4	ON/OFF	max. 300 W	PO1016	1.848,74 €	2.200,00 €
	<b>15 Arme 75 cm beige, Schirme rubinrot</b> 15 arms 75 cm beige, shades ruby red	15 × G4	ON/OFF	max. 300 W	PO1014	1.764,71 €	2.100,00 €
	<b>15 Arme 150 cm beige, Schirme rubinrot</b> 15 arms 150 cm beige, shades ruby red	15 × G4	ON/OFF	max. 300 W	PO1017	1.848,74 €	2.200,00 €
	<b>15 Arme 75 cm beige, Schirme violett</b> 15 arms 75 cm beige, shades violet	15 × G4	ON/OFF	max. 300 W	PO1015	1.764,71 €	2.100,00 €
	<b>15 Arme 150 cm beige, Schirme violett</b> 15 arms 150 cm beige, shades violet	15 × G4	ON/OFF	max. 300 W	PO1018	1.848,74 €	2.200,00 €

## REEF Wall

Die unverwechselbaren Leuchtschirme dieser Familie bestehen aus innovativer Schaumkeramik, deren Struktur stark an Korallen erinnert. Dabei sind sie durabel, spülmaschinentauglich und verteilen das Streulicht perfekt in einem sanften Bone China-Farbton. Die zylindrischen Körper sind einseitig offen – so strahlen die Leuchten dieser Familie kräftig und brillant, aber völlig blendfrei.

The unmistakable lamp shades in this family are made of innovative foam ceramic, whose texture is highly reminiscent of corals. That said they are durable, dishwasher-proof and distribute the scattered light perfectly in a gentle bone china hue. The cylindrical objects are open on one side, such that the lamps in this family shine powerfully and brightly, though without any glare at all.



reddot design award  
winner 2004

DESIGN PLUS

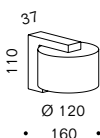

downlight

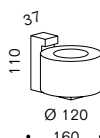

uplight

<b>Licht</b> light	<b>nach unten gerichtet, rundum diffus</b> directed downwards, diffuse all around
<b>Leuchtmittel</b> lamp	LED 8 W, CoB, CRI Ra>97, EEK/EEC F G9 max. 60 W, EEK/EEC G
<b>Gehäuse</b> Housing	<b>Aluminium poliert oder gebürstet; Leuchtschirm: Keramikschaum weiß</b> aluminium polished or brushed; shade: ceramic foam white
<b>Sonstiges</b> features	<b>Schirm werkzeuglos abnehmbar und spülmaschinenfest; LED austauschbar; kann als Up- oder Downlight montiert werden</b> shade tool-free removable and dishwasher safe; LED exchangeable; can be mounted upwards or downwards

## REEF Wall

Abbildung figure	Beschreibung description	Leuchtmittel lamp	Regelung control	Leistung power	CCT	Lumen lumen	Art.-Nr. art.-no.	€ netto DE excl. VAT	€ brutto DE incl. VAT
●	<b>gebürstet</b> brushed	LED	TRIAC	8 W	2700 K	790 lm	RF2057	386,55 €	460,00 €
		G9	TRIAC	max. 60 W	2700 K	740 lm	RF1002	289,92 €	345,00 €
●	<b>poliert</b> polished	LED	TRIAC	8 W	2700 K	790 lm	RF2058	411,76 €	490,00 €
		G9	TRIAC	max. 60 W	2700 K	740 lm	RF1001	310,92 €	370,00 €

## REFLEX<sup>2</sup> Wall

REFLEX<sup>2</sup> Wall reduziert die Formensprache der Produktfamilie auf das Wesentliche und komplettiert sie mit einer extrem flachen Wandleuchte. REFLEX<sup>2</sup> Wall greift als Uplight das Prinzip der indirekten Beleuchtung auf, die intensives, weiches Licht über Decke und Wand in den Raum strahlt und so für ein absolut blendfreies Licht im Büro, in Privaträumen oder im Objektbereich sorgt.

REFLEX<sup>2</sup> Wall reduces the design language of the product family to the essentials and completes it with an extremely flat wall luminaire. As an uplight, REFLEX<sup>2</sup> Wall picks up on the principle of indirect lighting, emitting intense, soft light into the room via the ceiling and wall, thus providing absolutely glare-free light for offices, private rooms and more extensive projects.

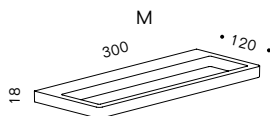

**Licht**  
light **nach oben oder unten gerichtet, indirekt über Wand und Decke**  
directed upwards, indirectly via wall and ceiling

**Leuchtmittel**  
lamp **LED 12 W, CRI Ra>90 (R9>50), EEK/EEC E**

**Gehäuse**  
housing **Aluminium schwarz oder weiß beschichtet**  
aluminium black or white coated

**Material**  
material **Leuchtmittelabdeckung: Flachglas satinée**  
lamp cover: glass semigloss



**Sonstiges**  
features **LED austauschbar; kann als Up- oder Downlight montiert werden**  
LED exchangeable; can be mounted upwards or downwards

## REFLEX<sup>2</sup> Wall M

Abbildung figure	Beschreibung description	Leuchtmittel lamp	Regelung control	Leistung power	CCT	Lumen lumen	Art.-Nr. art.-no.	€ netto DE excl. VAT	€ brutto DE incl. VAT
●	<b>schwarz</b> black	LED	TRIAC	12 W	2700 K	1420 lm	RE4001	319,33 €	380,00 €
					3000 K	1470 lm	RE4003	319,33 €	380,00 €
○	<b>weiß</b> white	LED	TRIAC	12 W	2700 K	1420 lm	RE4002	319,33 €	380,00 €
					3000 K	1470 lm	RE4004	319,33 €	380,00 €

## REFLEX<sup>2</sup> Wall M – Zubehör / Accessories

**Wandabdeckungen** Zur Abdeckung von z. B. Anschlussdosen finden Sie passende Wandabdeckungen auf Seite 203.  
Wall covers To cover e.g. junction boxes wall matching covers can be found on page 203.

## ROD Wall

Mit einem reduzierten Glaskörper in einem abgerundeten, kubischen Glasprofil erhält ROD die Anmutung einer minimalistischen Wandvitrine. Aufgrund ihres leichten Wandabstands wird sie zur schwebenden, fast schon architektonischen vertikalen Struktur. Mit einem illuminierten Innenkörper und den unterschiedlichen Innenschirmen lassen sich verschiedene Lichtszenarien schaffen.



With its reduced glass body in a rounded, cubic glass profile, ROD appears like a minimalist display cabinet mounted on the wall. The slight gap between the luminaire and the wall turns it into a floating, almost architectural vertical structure. Various lighting scenarios may be created with the illuminated inner body and the very different inner shades.



**Licht**  
light **direkt nach oben und unten, nach vorne diffus oder abgeschirmt**  
directed upwards and downwards, forwards diffuse or shielded

**Leuchtmittel**  
lamp LED 27 W, CRI Ra>90, R9>50, EEK/EEC F

**Gehäuse**  
Housing **Glasschirm: Borosilikatglasrohr; Gehäuse: Aluminium weiß beschichtet**  
glass shade: borosilicate glass tube; body: aluminium white coated

**Innenschirm**  
inner shade **Acrylglas opal, Aluminium glanzverchromt oder gold eloxiert**  
acrylic satinée opal, aluminium chrome plated or gold anodized



**Sonstiges**  
features **LED austauschbar; weitere Ausführungen (CCT/CRI) und andere Oberflächen auf Anfrage erhältlich.**  
LED exchangeable; other versions (CCT/CRI) and different coatings available on request.

## ROD Wall

Abbildung figure	Beschreibung description	Leuchtmittel lamp	Regelung control	Leistung power	CCT	Lumen lumen	Art.-Nr. art.-no.	€ netto DE excl. VAT	€ brutto DE incl. VAT
○	opal opal	LED	TRIAC 0–10 V	27 W	2700 K	3180 lm	RD1001	470,59 €	560,00 €
			DALI	27 W	2700 K	3180 lm	RD1009	495,80 €	590,00 €
●	glanzverchromt chrome plated	LED	TRIAC 0–10 V	27 W	2700 K	3180 lm	RD1002	470,59 €	560,00 €
			DALI	27 W	2700 K	3180 lm	RD1010	495,80 €	590,00 €
●	gold eloxiert gold anodized	LED	TRIAC 0–10 V	27 W	2700 K	3180 lm	RD1018	470,59 €	560,00 €
			DALI	27 W	2700 K	3180 lm	RD1021	495,80 €	590,00 €

## SML Wall

Als Baukastensystem konzipiert, bietet das SML-Programm eine Fülle an Einsatzmöglichkeiten. Konsequente Gestaltung hat seine Abmessungen auf das Minimum reduziert: 25 mm Bauhöhe. Die für oben und unten frei wählbaren unterschiedlichen Leuchtmittelabdeckungen ermöglichen eine individuelle Lichtlenkung – symmetrisch nach oben und unten streuend oder zu einer Seite abgeblendet. So können repräsentative Büros oder Wohnungen in einer einheitlichen Formensprache beleuchtet werden, ohne dabei auf unterschiedliche Lichtqualitäten verzichten zu müssen.

Conceived as a modular system, the SML range can be used for a variety of purposes. A consistent design has pared its dimensions down to a minimum: 25 mm in height. The different illuminant covers, which can be chosen freely for top and bottom, allow the light to be directed individually – symmetrically scattering upward and downward or shielded to one side. This way, for example, prestigious offices and apartments can be illuminated in a uniform formal language, without having to do without differing qualities of light.

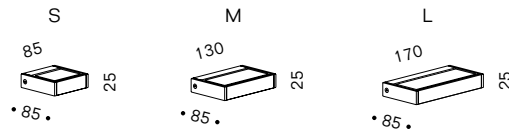

<b>Licht</b> light	<b>Abhängig von gewählter Leuchtmittelabdeckung symmetrisch nach oben und unten gestreut oder zu einer Seite gestreut, zur anderen abgeblendet</b> depending on the chosen illuminant covers symmetrical scattering upward and downward or scattered to one side, dimmed to the other
-----------------------	--

<b>Leuchtmittel</b> lamp	S: 60 W G9, EEK/EEC G M: 120 W R7s, EEK/EEC G L: 160 W R7s, EEK/EEC G
-----------------------------	---

<b>Material</b> material	<b>Aluminium eloxiert silber oder Aluminium glanzverchromt, Leuchtmittelabdeckungen: Keramikglas</b> aluminum anodized silver or aluminum chrome-plated, bulb covers: ceramic glass
-----------------------------	--





## SML Wall – Zubehör / Accessories

<b>Wandabdeckungen</b> Wall covers	<b>Zur Abdeckung von z. B. Anschlussdosen finden Sie passende Wandabdeckungen auf Seite 203.</b> To cover e.g. junction boxes wall matching covers can be found on page 203.
---------------------------------------	---













## SML Wall S

Abbildung figure	Beschreibung description	Fassung socket	Regelung control	Leistung power	Art.-Nr. art.-no.	€ netto DE excl. VAT	€ brutto DE incl. VAT
	<b>silber, satinée/satinée</b> silver, satinée/satinée	G9	TRIAC	max. 60 W	SM1172	243,70 €	290,00 €
	<b>silber, satinée/Raster</b> silver, satinée/raster	G9	TRIAC	max. 60 W	SM1199	243,70 €	290,00 €
	<b>glanzverchromt, satinée/satinée</b> chrome plated, satinée/satinée	G9	TRIAC	max. 60 W	SM3172	273,11 €	325,00 €
	<b>glanzverchromt, satinée/Raster</b> chrome plated, satinée/raster	G9	TRIAC	max. 60 W	SM3199	273,11 €	325,00 €

## SML Wall M

Abbildung figure	Beschreibung description	Fassung socket	Regelung control	Leistung power	Art.-Nr. art.-no.	€ netto DE excl. VAT	€ brutto DE incl. VAT
	<b>silber, satinée/satinée</b> silver, satinée/satinée	R7s	TRIAC	max. 120 W	SM1173	260,50 €	310,00 €
	<b>silber, satinée/Raster</b> silver, satinée/raster	R7s	TRIAC	max. 120 W	SM1198	260,50 €	310,00 €
	<b>glanzverchromt, satinée/satinée</b> chrome plated, satinée/satinée	R7s	TRIAC	max. 120 W	SM3173	294,12 €	350,00 €
	<b>glanzverchromt, satinée/Raster</b> chrome plated, satinée/raster	R7s	TRIAC	max. 120 W	SM3177	294,12 €	350,00 €

## SML Wall L

Abbildung figure	Beschreibung description	Fassung socket	Regelung control	Leistung power	Art.-Nr. art.-no.	€ netto DE excl. VAT	€ brutto DE incl. VAT
	<b>silber, satinée/satinée</b> silver, satinée/satinée	R7s	TRIAC	max. 160 W	SM1174	285,71 €	340,00 €
	<b>silber, satinée/Raster</b> silver, satinée/raster	R7s	TRIAC	max. 160 W	SM1175	285,71 €	340,00 €
	<b>glanzverchromt, satinée/satinée</b> chrome plated, satinée/satinée	R7s	TRIAC	max. 160 W	SM3174	323,53 €	385,00 €
	<b>glanzverchromt, satinée/Raster</b> chrome plated, satinée/raster	R7s	TRIAC	max. 160 W	SM3176	323,53 €	385,00 €

## SML<sup>2</sup> Wall

Mit ihrem radikal reduzierten Design und exklusiver Ausstattung hat sich die SML-Familie als ein Markenzeichen des Unternehmens etabliert. Die SML<sup>2</sup>-Linie eröffnet mit sechs Größenausführungen erweiterte Einsatzmöglichkeiten und Modularität. Auch SML<sup>2</sup> ist mit nur 25 mm Bauhöhe modular kombinierbar mit allen anderen Versionen.

With its radically reduced design and exclusive features, the SML line has established itself as one of the series trademark ranges. The SML<sup>2</sup> line comes in six lengths and offers wide application range and extended modularity. With its height of just 25 mm SML<sup>2</sup> can be modularly combined with all other versions.

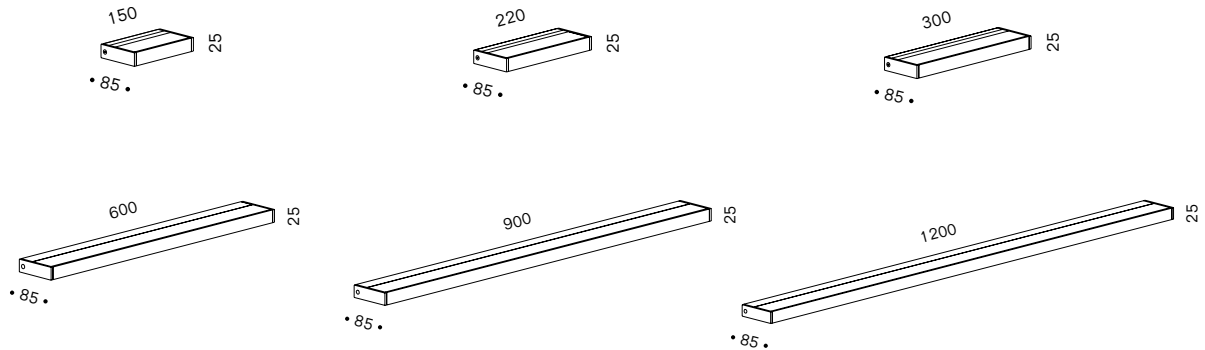

<b>Licht</b> light	<b>Abhängig von gewählter Leuchtmittelabdeckung symmetrisch nach oben und unten gestreut oder zu einer Seite gestreut, zur anderen abgeblendet</b> depending on the chosen illuminant covers symmetrical scattering upward and downward or scattered to one side, dimmed to the other
<b>Leuchtmittel</b> lamp	LED 10–40 W, CRI Ra>90 (R9>50), EEK/EEC F
<b>Material</b> material	<b>Aluminium poliert oder Aluminium schwarz, silber oder weiß lackiert; Leuchtmittelabdeckungen; Polycarbonat</b> aluminium polished or aluminium lacquered black, silver or white; Illuminant covers: polycarbonate
<b>Sonstiges</b> features	<b>LED austauschbar</b> LED exchangeable

## SML<sup>2</sup> Wall – Zubehör / Accessories

<b>Wandabdeckungen</b> Wall covers	<b>Zur Abdeckung von z. B. Anschlussdosen finden Sie passende Wandabdeckungen auf Seite 203.</b> To cover e.g. junction boxes wall matching covers can be found on page 203.
<b>Wandadapter</b> Wall adapters	<b>Montagehilfe bei nicht mittigem Stromanschluss finden Sie auf Seite 202.</b> Mounting aid for centered power connection can be found on page 202.









## SML<sup>2</sup> Wall 150

Abbildung figure	Beschreibung description	Leuchtmittel lamp	Regelung control	Leistung power	CCT	Lumen lumen	Art.-Nr. art.-no.	€ netto DE excl. VAT	€ brutto DE incl. VAT
● ⊖	<b>silber, satinée/satinée</b> silver, satinée/satinée	LED	ON/OFF	10 W	2700 K	1110 lm	SM1325	348,74 €	415,00 €
					3000 K	1130 lm	SM1227	348,74 €	415,00 €
● ⊕	<b>silber, satinée/Raster</b> silver, satinée/raster	LED	ON/OFF	10 W	2700 K	1110 lm	SM1326	348,74 €	415,00 €
					3000 K	1130 lm	SM1228	348,74 €	415,00 €
○ ⊖	<b>weiß, satinée/satinée</b> white, satinée/satinée	LED	ON/OFF	10 W	2700 K	1110 lm	SM1327	348,74 €	415,00 €
					3000 K	1130 lm	SM1229	348,74 €	415,00 €
○ ⊕	<b>weiß, satinée/Raster</b> white, satinée/raster	LED	ON/OFF	10 W	2700 K	1110 lm	SM1328	348,74 €	415,00 €
					3000 K	1130 lm	SM1230	348,74 €	415,00 €
● ⊖	<b>schwarz, satinée/satinée</b> black, satinée/satinée	LED	ON/OFF	10 W	2700 K	1110 lm	SM1329	348,74 €	415,00 €
					3000 K	1130 lm	SM1231	348,74 €	415,00 €
● ⊕	<b>schwarz, satinée/Raster</b> black, satinée/raster	LED	ON/OFF	10 W	2700 K	1110 lm	SM1330	348,74 €	415,00 €
					3000 K	1130 lm	SM1232	348,74 €	415,00 €
● ⊖	<b>poliert, satinée/satinée</b> polished, satinée/satinée	LED	ON/OFF	10 W	2700 K	1110 lm	SM1331	394,96 €	470,00 €
					3000 K	1130 lm	SM1233	394,96 €	470,00 €
● ⊕	<b>poliert, satinée/Raster</b> polished, satinée/raster	LED	ON/OFF	10 W	2700 K	1110 lm	SM1332	394,96 €	470,00 €
					3000 K	1130 lm	SM1234	394,96 €	470,00 €









## SML<sup>2</sup> Wall 220

Abbildung figure	Beschreibung description	Leuchtmittel lamp	Regelung control	Leistung power	CCT	Lumen lumen	Art.-Nr. art.-no.	€ netto DE excl. VAT	€ brutto DE incl. VAT
● ⊖	<b>silber, satinée/satinée</b> silver, satinée/satinée	LED	TRIAC	15 W	2700 K	1540 lm	SM1333	436,97 €	520,00 €
					3000 K	1560 lm	SM1235	436,97 €	520,00 €
● ⊕	<b>silber, satinée/Raster</b> silver, satinée/raster	LED	TRIAC	15 W	2700 K	1540 lm	SM1334	436,97 €	520,00 €
					3000 K	1560 lm	SM1236	436,97 €	520,00 €
○ ⊖	<b>weiß, satinée/satinée</b> white, satinée/satinée	LED	TRIAC	15 W	2700 K	1540 lm	SM1335	436,97 €	520,00 €
					3000 K	1560 lm	SM1237	436,97 €	520,00 €
○ ⊕	<b>weiß, satinée/Raster</b> white, satinée/raster	LED	TRIAC	15 W	2700 K	1540 lm	SM1336	436,97 €	520,00 €
					3000 K	1560 lm	SM1238	436,97 €	520,00 €
● ⊖	<b>schwarz, satinée/satinée</b> black, satinée/satinée	LED	TRIAC	15 W	2700 K	1540 lm	SM1337	436,97 €	520,00 €
					3000 K	1560 lm	SM1239	436,97 €	520,00 €
● ⊕	<b>schwarz, satinée/Raster</b> black, satinée/raster	LED	TRIAC	15 W	2700 K	1540 lm	SM1338	436,97 €	520,00 €
					3000 K	1560 lm	SM1240	436,97 €	520,00 €
● ⊖	<b>poliert, satinée/satinée</b> polished, satinée/satinée	LED	TRIAC	15 W	2700 K	1540 lm	SM1339	478,99 €	570,00 €
					3000 K	1560 lm	SM1241	478,99 €	570,00 €
● ⊕	<b>poliert, satinée/Raster</b> polished, satinée/raster	LED	TRIAC	15 W	2700 K	1540 lm	SM1340	478,99 €	570,00 €
					3000 K	1560 lm	SM1242	478,99 €	570,00 €









## SML<sup>2</sup> Wall 300

Abbildung figure	Beschreibung description	Leuchtmittel lamp	Regelung control	Leistung power	CCT	Lumen lumen	Art.-Nr. art.-no.	€ netto DE excl. VAT	€ brutto DE incl. VAT
	<b>silber, satinée/satinée</b> silver, satinée/satinée	LED	TRIAC	20 W	2700 K	2090 lm	SM1341	529,41 €	630,00 €
					3000 K	2130 lm	SM1243	529,41 €	630,00 €
			DALI	20 W	2700 K	2090 lm	SM1601	554,62 €	660,00 €
					3000 K	2130 lm	SM1602	554,62 €	660,00 €
	<b>silber, satinée/Raster</b> silver, satinée/raster	LED	TRIAC	20 W	2700 K	2090 lm	SM1342	529,41 €	630,00 €
					3000 K	2130 lm	SM1244	529,41 €	630,00 €
			DALI	20 W	2700 K	2090 lm	SM1603	554,62 €	660,00 €
					3000 K	2130 lm	SM1604	554,62 €	660,00 €
	<b>weiß, satinée/satinée</b> white, satinée/satinée	LED	TRIAC	20 W	2700 K	2090 lm	SM1343	529,41 €	630,00 €
					3000 K	2130 lm	SM1245	529,41 €	630,00 €
			DALI	20 W	2700 K	2090 lm	SM1605	554,62 €	660,00 €
					3000 K	2130 lm	SM1606	554,62 €	660,00 €
	<b>weiß, satinée/Raster</b> white, satinée/raster	LED	TRIAC	20 W	2700 K	2090 lm	SM1344	529,41 €	630,00 €
					3000 K	2130 lm	SM1246	529,41 €	630,00 €
			DALI	20 W	2700 K	2090 lm	SM1607	554,62 €	660,00 €
					3000 K	2130 lm	SM1608	554,62 €	660,00 €
	<b>schwarz, satinée/satinée</b> black, satinée/satinée	LED	TRIAC	20 W	2700 K	2090 lm	SM1345	529,41 €	630,00 €
					3000 K	2130 lm	SM1247	529,41 €	630,00 €
			DALI	20 W	2700 K	2090 lm	SM1609	554,62 €	660,00 €
					3000 K	2130 lm	SM1610	554,62 €	660,00 €
	<b>schwarz, satinée/Raster</b> black, satinée/raster	LED	TRIAC	20 W	2700 K	2090 lm	SM1346	529,41 €	630,00 €
					3000 K	2130 lm	SM1248	529,41 €	630,00 €
			DALI	20 W	2700 K	2090 lm	SM1611	554,62 €	660,00 €
					3000 K	2130 lm	SM1612	554,62 €	660,00 €
	<b>poliert, satinée/satinée</b> polished, satinée/satinée	LED	TRIAC	20 W	2700 K	2090 lm	SM1347	571,43 €	680,00 €
					3000 K	2130 lm	SM1249	571,43 €	680,00 €
			DALI	20 W	2700 K	2090 lm	SM1613	596,64 €	710,00 €
					3000 K	2130 lm	SM1614	596,64 €	710,00 €
	<b>poliert, satinée/Raster</b> polished, satinée/raster	LED	TRIAC	20 W	2700 K	2090 lm	SM1348	571,43 €	680,00 €
					3000 K	2130 lm	SM1250	571,43 €	680,00 €
			DALI	20 W	2700 K	2090 lm	SM1615	596,64 €	710,00 €
					3000 K	2130 lm	SM1616	596,64 €	710,00 €

# SML<sup>2</sup> Wall 600

Abbildung figure	Beschreibung description	Leuchtmittel lamp	Regelung control	Leistung power	CCT	Lumen lumen	Art.-Nr. art.-no.	€ netto DE excl. VAT	€ brutto DE incl. VAT
	<b>silber, satinée/satinée</b> silver, satinée/satinée	LED	TRIAC	20 W	2700 K	2050 lm	SM1701	529,41 €	630,00 €
					3000 K	2080 lm	SM1801	529,41 €	630,00 €
					2700 K	2050 lm	SM1349	529,41 €	630,00 €
			DALI	20 W	3000 K	2080 lm	SM1251	529,41 €	630,00 €
					2700 K–5000 K TW	2100 lm	SM1501	571,43 €	680,00 €
					<hr/>				
	<b>silber, satinée/Raster</b> silver, satinée/raster	LED	TRIAC	20 W	2700 K	2050 lm	SM1702	529,41 €	630,00 €
					3000 K	2080 lm	SM1802	529,41 €	630,00 €
					2700 K	2050 lm	SM1350	529,41 €	630,00 €
			DALI	20 W	3000 K	2080 lm	SM1252	529,41 €	630,00 €
					2700 K–5000 K TW	2100 lm	SM1502	571,43 €	680,00 €
					<hr/>				
	<b>weiß, satinée/satinée</b> white, satinée/satinée	LED	TRIAC	20 W	2700 K	2050 lm	SM1703	529,41 €	630,00 €
					3000 K	2080 lm	SM1803	529,41 €	630,00 €
					2700 K	2050 lm	SM1351	529,41 €	630,00 €
			DALI	20 W	3000 K	2080 lm	SM1253	529,41 €	630,00 €
					2700 K–5000 K TW	2100 lm	SM1503	571,43 €	680,00 €
					<hr/>				
	<b>weiß, satinée/Raster</b> white, satinée/raster	LED	TRIAC	20 W	2700 K	2050 lm	SM1704	529,41 €	630,00 €
					3000 K	2080 lm	SM1804	529,41 €	630,00 €
					2700 K	2050 lm	SM1352	529,41 €	630,00 €
			DALI	20 W	3000 K	2080 lm	SM1254	529,41 €	630,00 €
					2700 K–5000 K TW	2100 lm	SM1504	571,43 €	680,00 €
					<hr/>				
	<b>schwarz, satinée/satinée</b> black, satinée/satinée	LED	TRIAC	20 W	2700 K	2050 lm	SM1705	529,41 €	630,00 €
					3000 K	2080 lm	SM1805	529,41 €	630,00 €
					2700 K	2050 lm	SM1353	529,41 €	630,00 €
			DALI	20 W	3000 K	2080 lm	SM1255	529,41 €	630,00 €
					2700 K–5000 K TW	2100 lm	SM1505	571,43 €	680,00 €
					<hr/>				
	<b>schwarz, satinée/Raster</b> black, satinée/raster	LED	TRIAC	20 W	2700 K	2050 lm	SM1706	529,41 €	630,00 €
					3000 K	2080 lm	SM1806	529,41 €	630,00 €
					2700 K	2050 lm	SM1354	529,41 €	630,00 €
			DALI	20 W	3000 K	2080 lm	SM1256	529,41 €	630,00 €
					2700 K–5000 K TW	2100 lm	SM1506	571,43 €	680,00 €
					<hr/>				
	<b>poliert, satinée/satinée</b> polished, satinée/satinée	LED	TRIAC	20 W	2700 K	2050 lm	SM1707	571,43 €	680,00 €
					3000 K	2080 lm	SM1807	571,43 €	680,00 €
					2700 K	2050 lm	SM1355	571,43 €	680,00 €
			DALI	20 W	3000 K	2080 lm	SM1257	571,43 €	680,00 €
					2700 K–5000 K TW	2100 lm	SM1507	621,85 €	740,00 €
					<hr/>				
	<b>poliert, satinée/Raster</b> polished, satinée/raster	LED	TRIAC	20 W	2700 K	2050 lm	SM1708	571,43 €	680,00 €
					3000 K	2080 lm	SM1808	571,43 €	680,00 €
					2700 K	2050 lm	SM1356	571,43 €	680,00 €
			DALI	20 W	3000 K	2080 lm	SM1258	571,43 €	680,00 €
					2700 K–5000 K TW	2100 lm	SM1508	621,85 €	740,00 €
					<hr/>				

# SML<sup>2</sup> Wall 900

Abbildung figure	Beschreibung description	Leuchtmittel lamp	Regelung control	Leistung power	CCT	Lumen lumen	Art.-Nr. art.-no.	€ netto DE excl. VAT	€ brutto DE incl. VAT
	<b>silber, satinée/satinée</b> silver, satinée/satinée	LED	TRIAC	30 W	2700 K	3070 lm	SM1709	579,83 €	690,00 €
					3000 K	3120 lm	SM1809	579,83 €	690,00 €
					2700 K	3070 lm	SM1357	579,83 €	690,00 €
			DALI	30 W	3000 K	3120 lm	SM1259	579,83 €	690,00 €
					2700 K–5000 K TW	3200 lm	SM1511	647,06 €	770,00 €
					2700 K	3070 lm	SM1710	579,83 €	690,00 €
	<b>silber, satinée/Raster</b> silver, satinée/raster	LED	TRIAC	30 W	3000 K	3120 lm	SM1810	579,83 €	690,00 €
					2700 K	3070 lm	SM1358	579,83 €	690,00 €
					2700 K	3070 lm	SM1358	579,83 €	690,00 €
			DALI	30 W	3000 K	3120 lm	SM1260	579,83 €	690,00 €
					2700 K–5000 K TW	3200 lm	SM1512	647,06 €	770,00 €
					2700 K	3070 lm	SM1711	579,83 €	690,00 €
	<b>weiß, satinée/satinée</b> white, satinée/satinée	LED	TRIAC	30 W	3000 K	3120 lm	SM1811	579,83 €	690,00 €
					2700 K	3070 lm	SM1359	579,83 €	690,00 €
					2700 K	3070 lm	SM1359	579,83 €	690,00 €
			DALI	30 W	3000 K	3120 lm	SM1261	579,83 €	690,00 €
					2700 K–5000 K TW	3200 lm	SM1513	647,06 €	770,00 €
					2700 K	3070 lm	SM1712	579,83 €	690,00 €
	<b>weiß, satinée/Raster</b> white, satinée/raster	LED	TRIAC	30 W	3000 K	3120 lm	SM1812	579,83 €	690,00 €
					2700 K	3070 lm	SM1360	579,83 €	690,00 €
					2700 K	3070 lm	SM1360	579,83 €	690,00 €
			DALI	30 W	3000 K	3120 lm	SM1262	579,83 €	690,00 €
					2700 K–5000 K TW	3200 lm	SM1514	647,06 €	770,00 €
					2700 K	3070 lm	SM1713	579,83 €	690,00 €
	<b>schwarz, satinée/satinée</b> black, satinée/satinée	LED	TRIAC	30 W	3000 K	3120 lm	SM1813	579,83 €	690,00 €
					2700 K	3070 lm	SM1361	579,83 €	690,00 €
					2700 K	3070 lm	SM1361	579,83 €	690,00 €
			DALI	30 W	3000 K	3120 lm	SM1263	579,83 €	690,00 €
					2700 K–5000 K TW	3200 lm	SM1515	647,06 €	770,00 €
					2700 K	3070 lm	SM1714	579,83 €	690,00 €
	<b>schwarz, satinée/Raster</b> black, satinée/raster	LED	TRIAC	30 W	3000 K	3120 lm	SM1814	579,83 €	690,00 €
					2700 K	3070 lm	SM1362	579,83 €	690,00 €
					2700 K	3070 lm	SM1362	579,83 €	690,00 €
			DALI	30 W	3000 K	3120 lm	SM1264	579,83 €	690,00 €
					2700 K–5000 K TW	3200 lm	SM1516	647,06 €	770,00 €
					2700 K	3070 lm	SM1715	621,85 €	740,00 €
	<b>poliert, satinée/satinée</b> polished, satinée/satinée	LED	TRIAC	30 W	3000 K	3120 lm	SM1815	621,85 €	740,00 €
					2700 K	3070 lm	SM1363	621,85 €	740,00 €
					2700 K	3070 lm	SM1363	621,85 €	740,00 €
			DALI	30 W	3000 K	3120 lm	SM1265	621,85 €	740,00 €
					2700 K–5000 K TW	3200 lm	SM1517	689,08 €	820,00 €
					2700 K	3070 lm	SM1716	621,85 €	740,00 €
	<b>poliert, satinée/Raster</b> polished, satinée/raster	LED	TRIAC	30 W	3000 K	3120 lm	SM1816	621,85 €	740,00 €
					2700 K	3070 lm	SM1364	621,85 €	740,00 €
					2700 K	3070 lm	SM1364	621,85 €	740,00 €
			DALI	30 W	3000 K	3120 lm	SM1266	621,85 €	740,00 €
					2700 K–5000 K TW	3200 lm	SM1518	689,08 €	820,00 €
					2700 K	3070 lm	SM1716	621,85 €	740,00 €



# SML<sup>2</sup> Wall 1200

Abbildung figure	Beschreibung description	Leuchtmittel lamp	Regelung control	Leistung power	CCT	Lumen lumen	Art.-Nr. art.-no.	€ netto DE excl. VAT	€ brutto DE incl. VAT
● ⊖	<b>silber, satinée/satinée</b> silver, satinée/satinée	LED	TRIAC	40 W	2700 K	4000 lm	SM1717	663,87 €	790,00 €
					3000 K	4180 lm	SM1817	663,87 €	790,00 €
					2700 K	4000 lm	SM1365	663,87 €	790,00 €
			DALI	40 W	3000 K	4180 lm	SM1267	663,87 €	790,00 €
					2700 K–5000 K TW	4350 lm	SM1521	764,71 €	910,00 €
● ⊕	<b>silber, satinée/Raster</b> silver, satinée/raster	LED	TRIAC	40 W	2700 K	4000 lm	SM1718	663,87 €	790,00 €
					3000 K	4180 lm	SM1818	663,87 €	790,00 €
					2700 K	4000 lm	SM1366	663,87 €	790,00 €
			DALI	40 W	3000 K	4180 lm	SM1268	663,87 €	790,00 €
					2700 K–5000 K TW	4350 lm	SM1522	764,71 €	910,00 €
○ ⊖	<b>weiß, satinée/satinée</b> white, satinée/satinée	LED	TRIAC	40 W	2700 K	4000 lm	SM1719	663,87 €	790,00 €
					3000 K	4180 lm	SM1819	663,87 €	790,00 €
					2700 K	4000 lm	SM1367	663,87 €	790,00 €
			DALI	40 W	3000 K	4180 lm	SM1269	663,87 €	790,00 €
					2700 K–5000 K TW	4350 lm	SM1523	764,71 €	910,00 €
○ ⊕	<b>weiß, satinée/Raster</b> white, satinée/raster	LED	TRIAC	40 W	2700 K	4000 lm	SM1720	663,87 €	790,00 €
					3000 K	4180 lm	SM1820	663,87 €	790,00 €
					2700 K	4000 lm	SM1368	663,87 €	790,00 €
			DALI	40 W	3000 K	4180 lm	SM1270	663,87 €	790,00 €
					2700 K–5000 K TW	4350 lm	SM1524	764,71 €	910,00 €
● ⊖	<b>schwarz, satinée/satinée</b> black, satinée/satinée	LED	TRIAC	40 W	2700 K	4000 lm	SM1721	663,87 €	790,00 €
					3000 K	4180 lm	SM1821	663,87 €	790,00 €
					2700 K	4000 lm	SM1369	663,87 €	790,00 €
			DALI	40 W	3000 K	4180 lm	SM1271	663,87 €	790,00 €
					2700 K–5000 K TW	4350 lm	SM1525	764,71 €	910,00 €
● ⊕	<b>schwarz, satinée/Raster</b> black, satinée/raster	LED	TRIAC	40 W	2700 K	4000 lm	SM1722	663,87 €	790,00 €
					3000 K	4180 lm	SM1822	663,87 €	790,00 €
					2700 K	4000 lm	SM1370	663,87 €	790,00 €
			DALI	40 W	3000 K	4180 lm	SM1272	663,87 €	790,00 €
					2700 K–5000 K TW	4350 lm	SM1526	764,71 €	910,00 €
● ⊖	<b>poliert, satinée/satinée</b> polished, satinée/satinée	LED	TRIAC	40 W	2700 K	4000 lm	SM1723	705,88 €	840,00 €
					3000 K	4180 lm	SM1823	705,88 €	840,00 €
					2700 K	4000 lm	SM1371	705,88 €	840,00 €
			DALI	40 W	3000 K	4180 lm	SM1273	705,88 €	840,00 €
					2700 K–5000 K TW	4350 lm	SM1527	806,72 €	960,00 €
● ⊕	<b>poliert, satinée/Raster</b> polished, satinée/raster	LED	TRIAC	40 W	2700 K	4000 lm	SM1724	705,88 €	840,00 €
					3000 K	4180 lm	SM1824	705,88 €	840,00 €
					2700 K	4000 lm	SM1372	705,88 €	840,00 €
			DALI	40 W	3000 K	4180 lm	SM1274	705,88 €	840,00 €
					2700 K–5000 K TW	4350 lm	SM1528	806,72 €	960,00 €

WALL



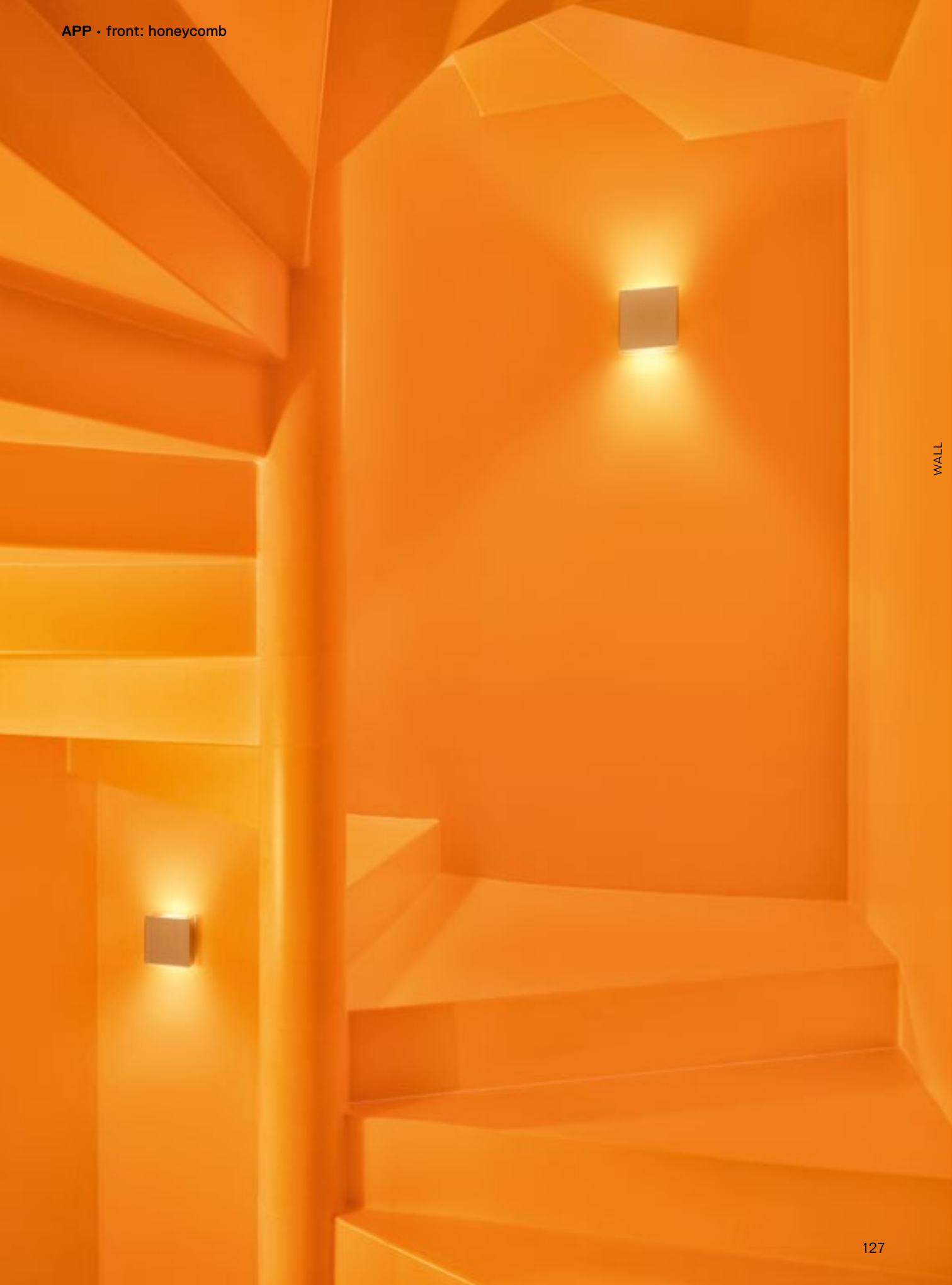



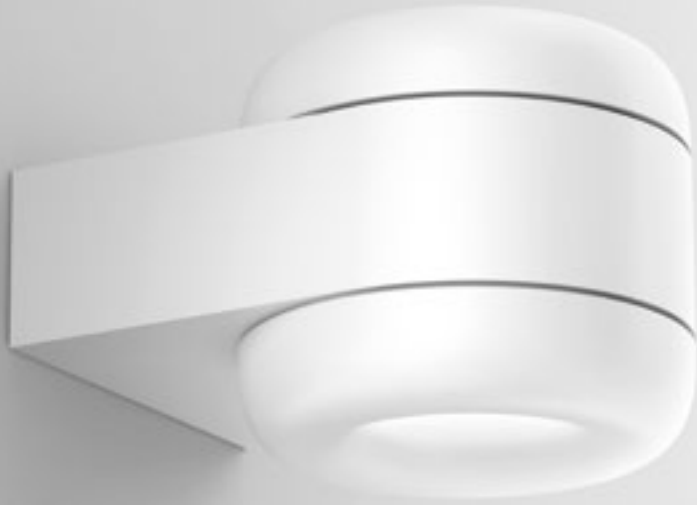







glass clear



glass new silver



acrylic glass clear





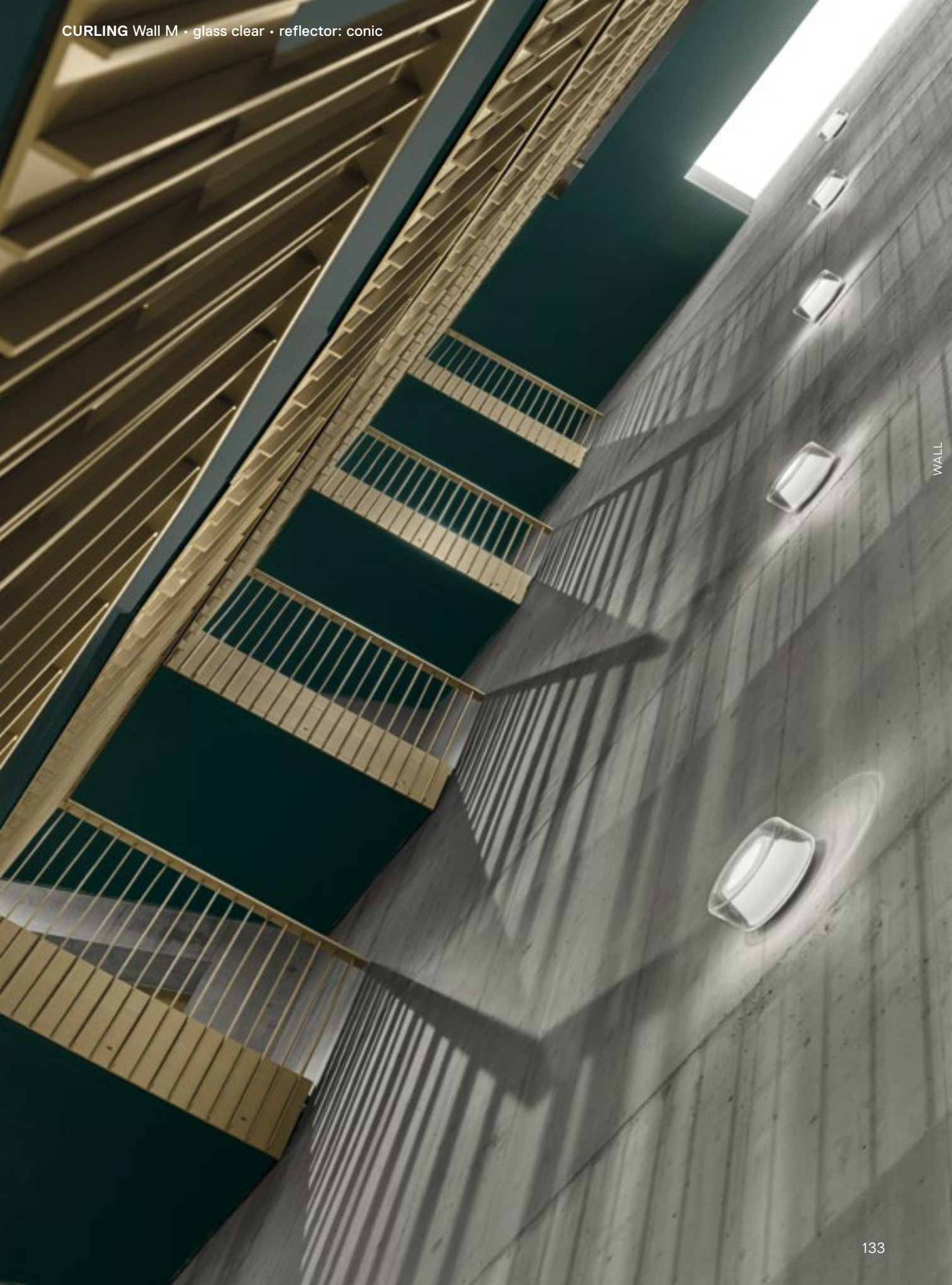







WALL











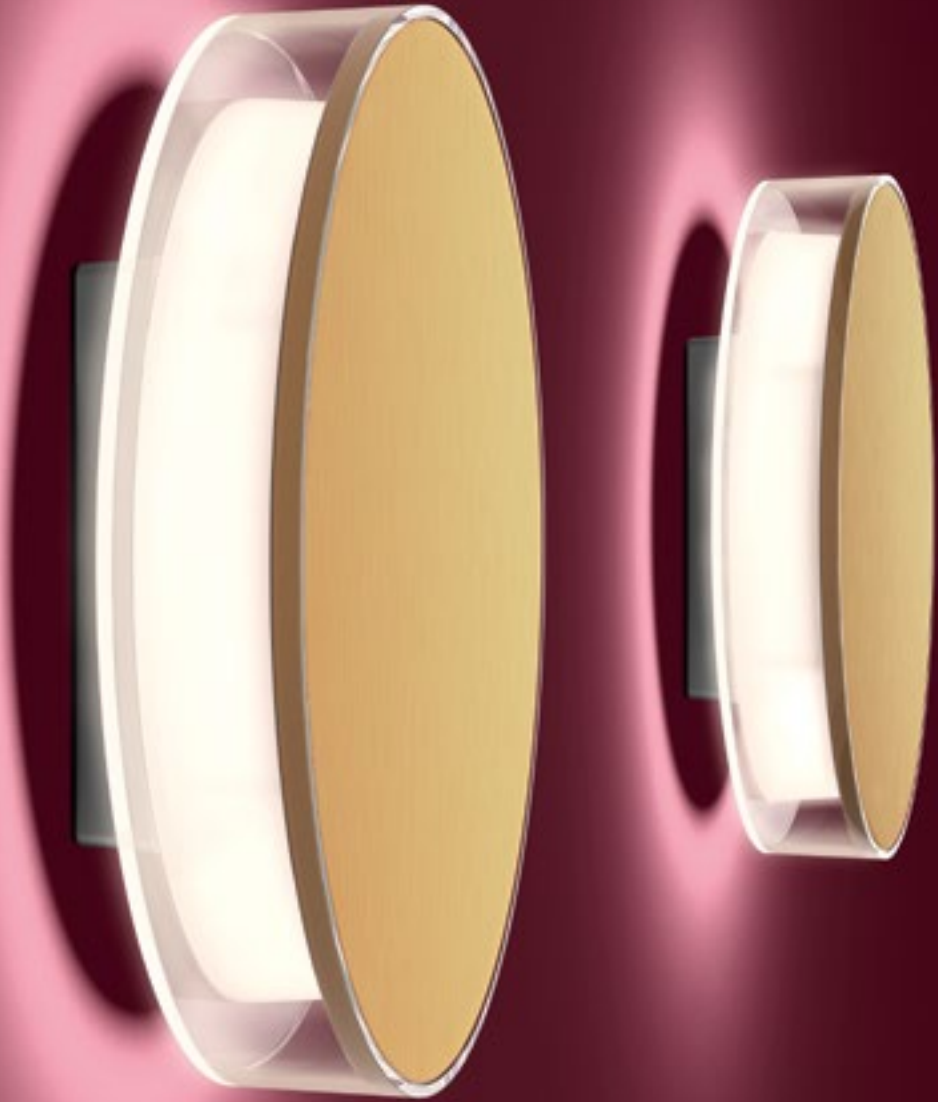



POPPY Wall • 2 arms: beige • shades: violet



3 arms: beige • shade: ceramic



3 arms: black • shade: ruby red



3 arms: black • shade: violet









REFLEX² Wall M · black



WALL

REFLEX² Wall M · white









WALL







WALL

5

• Futter für Wandverkleidung

4

• Stiegenkasten 270 - 270  
• 270er Wand-Elemente 270er  
• Futter für Wandverkleidung  
• Futter für Wandverkleidung  
• Futter für Wandverkleidung

3

• Stiegenkasten 270 - 270  
• Stiegenkasten 270 - 270  
• Futter für Wandverkleidung  
• 270er Wand-Elemente 270er  
• Futter für Wandverkleidung  
• Futter für Wandverkleidung

2

• Stiegenkasten 270 - 270  
• Stiegenkasten 270 - 270  
• Futter für Wandverkleidung  
• Futter für Wandverkleidung  
• Futter für Wandverkleidung  
• Futter für Wandverkleidung

1

• Stiegenkasten 180 - 180  
• Stiegenkasten 180 - 180  
• Futter für Wandverkleidung  
• Futter für Wandverkleidung  
• Futter für Wandverkleidung  
• Futter für Wandverkleidung

0

• Futter für Wandverkleidung  
• Futter für Wandverkleidung  
• Stiegenkasten 180 - 180  
• Futter für Wandverkleidung  
• Futter für Wandverkleidung

-1

• Futter für Wandverkleidung  
• Futter für Wandverkleidung  
• Futter für Wandverkleidung  
• Futter für Wandverkleidung  
• Futter für Wandverkleidung











polished

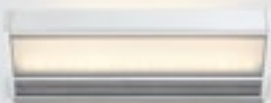

silver



black







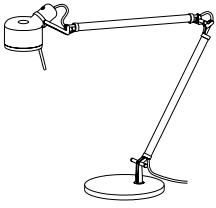

**JOB**  
S. 155



**POPPY**  
S. 156

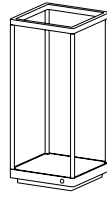

**REFLEX<sup>2</sup>**  
S. 157

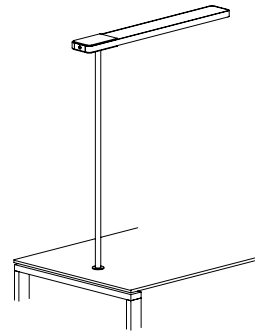

**SLICE<sup>2</sup>**  
S. 158





## JOB Table

An dieser exklusiven Variante der klassischen Schreibtischleuchte kann sich auch ein scharfes Auge lange erfreuen: alle Metallteile aus massivem, poliertem Edelstahl, Arme aus Echtglas, sorgfältigste Details (die Unterseite des Sockels ist mit Leder bezogen). JOB überzeugt auch funktional: auch bei Höchstleistung bleibt der Leuchtenkopf kühl. Dort– Wo man ihn braucht–ist auch der Schalter/Dimmer. Und Sie haben vier Befestigungen zur Wahl: Tisch-Sockel oder Tisch-Klemme, Möbeladapter für direktes Einstecken in Tischplatten oder Adapter für USM Haller-Tischsysteme.



Even a keen eye will enjoy a good long look at this exclusive version of the classic writing desk lamp: desk lamp: solid, polished stainless steel parts, genuine glass arms and great attention to details (the bottom of the base is covered with leather) JOB also stands out with regard to function: even when fully operational the head of the lamp remains cool. The switch/dimmer is also just where it is needed. And there is a choice of four mounts: Table-base or table-clamp, furniture adapter for direct fitting onto table tops or adapter for USM Haller table systems.

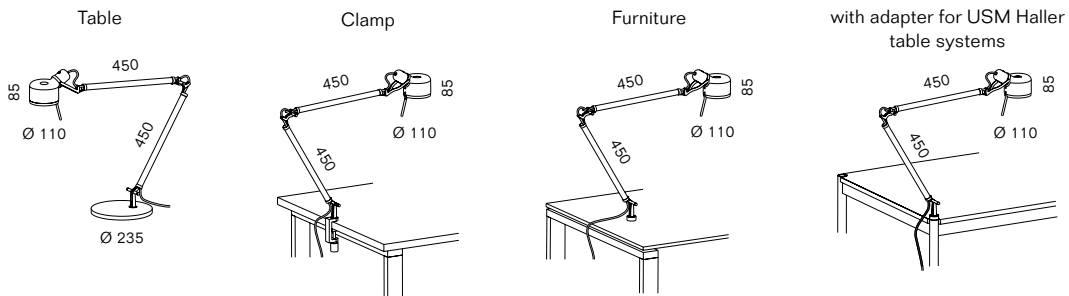

<b>Licht</b> light	<b>direkt, seitlich abgeschirmt</b> directly, laterally shielded
<b>Leuchtmittel</b> lamp	LED 13 W E27, CRI Ra>90 (R9>50), EEK/EEC D
<b>Material</b> material	<b>Tisch-Sockel: Edelstahl poliert, unterseitig Echtleder; Tisch-Klemme und -Adapter: Edelstahl poliert</b> <b>Rohre: Borosilikatglas und Edelstahl poliert; Schirm: Edelstahl poliert und Borosilikatglas</b> table base: stainless steel polished, bottom side real leather; table clamp and furniture adapter: stainless steel polished, tubes: borosilicate glass and stainless steel polished; shade: stainless steel polished and borosilicate glass
<b>Sonstiges</b> features	<b>LED-Retrofit in Lieferung enthalten; An/Aus Dimmung über Taster am Leuchtenkopf</b> LED-Retrofit included in delivery; on/off dimming via button on the head

## JOB Table

Abbildung figure	Beschreibung description	Leuchtmittel lamp	Regelung control	Leistung power	CCT	Lumen lumen	Art.-Nr. art.-no.	€ netto DE excl. VAT	€ brutto DE incl. VAT
	<b>Table</b>	LED E27	integr.	13 W	2200–2700 K D2W	1521 lm	JB1013	1.218,49 €	1.450,00 €
	<b>Clamp</b>	LED E27	integr.	13 W	2200–2700 K D2W	1521 lm	JB1014	1.025,21 €	1.220,00 €
	<b>Furniture</b>	LED E27	integr.	13 W	2200–2700 K D2W	1521 lm	JB1015	941,18 €	1.120,00 €
	<b>mit Adapter für USM Haller Tischsysteme</b> with adapter for USM Haller table systems	LED E27	integr.	13 W	2200–2700 K D2W	1521 lm	JB1016	941,18 €	1.120,00 €

## POPPY Table

Werden die „Mohnblüten“ dieser Familie durch Einschalten geweckt, öffnen sich ihre Schirme ganz allmählich: die feinen Blätter sind aus Bimetall und dehnen sich durch Erwärmung aus. Alle Varianten können nach Belieben umgestaltet werden. Der flexible, textilmantelte Schlauch lässt sich immer neu biegen – zur Änderung der Lichtrichtung, oder einfach weil Ihnen danach ist. Die mundgeblasenen Glaskapseln sind erhältlich in den Farben keramik, rubinrot oder violett.

When the “poppy flowers” in this family are woken by the lamp being switched on, their shades open very gradually: the delicate leaves are bi-metallic and expand when heated. All the versions can be reshaped as desired. The flexible, textile-coated stem can be bent at will, to change the direction of the light, or because you just feel like it. The hand-blown glass capsules are available in the colours ceramic, ruby red or violet.

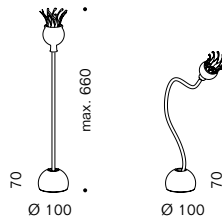

<b>Licht</b> light	<b>nach vorne gerichtet, seitlich abgeschirmt</b> directed forward, shielded to the sides
<b>Leuchtmittel</b> lamp	G4 35 W, 12 V, EEK/EEC G
<b>Material</b> material	<b>Arme, flexibel: Aluminium, textilmantelt beige oder schwarz; Glasschirme: mundgeblasenes Glas in keramik, rubinrot oder violett; Lamellen: Bimetall; Sockel: Edelstahl, poliert</b> arms, flexible: textile coated aluminium tube in beige or black; glass shade: hand-blown glass in ceramic, ruby red or violet; lamellae: bimetal; base: stainless steel, polished
<b>Sonstiges</b> features	<b>Leuchtmittel in Lieferung enthalten; Reflektor-Lamellen öffnen sich nach ca. 2 Minuten Betriebszeit; Leuchte kann auch als Wandleuchte montiert werden</b> lamps included in delivery; lamellae open within approx. 2 minutes after switching on luminaire; luminaire can also be mounted as wall luminaire

## POPPY Table

Abbildung figure	Beschreibung description	Fassung socket	Regelung control	Leistung power	Art.-Nr. art.-no.	€ netto DE excl. VAT	€ brutto DE incl. VAT
	<b>Arme schwarz, Schirm keramik</b> arms black, shade ceramic	G4	ON/OFF	max. 35 W	PO1001	352,94 €	420,00 €
	<b>Arme schwarz, Schirm rubinrot</b> arms black, shade ruby red	G4	ON/OFF	max. 35 W	PO1002	352,94 €	420,00 €
	<b>Arme schwarz, Schirm violett</b> arms black, shade violet	G4	ON/OFF	max. 35 W	PO1003	352,94 €	420,00 €
	<b>Arme beige, Schirm keramik</b> arms beige shade ceramic	G4	ON/OFF	max. 35 W	PO1022	352,94 €	420,00 €
	<b>Arme beige, Schirm rubinrot</b> arms beige shade ruby red	G4	ON/OFF	max. 35 W	PO1023	352,94 €	420,00 €
	<b>Arme beige, Schirm violett</b> arms beige shade violet	G4	ON/OFF	max. 35 W	PO1024	352,94 €	420,00 €

## REFLEX<sup>2</sup> Table

REFLEX<sup>2</sup> Table erweitert die Produktfamilie um eine feine, filigrane Tischleuchte. Mit ihrer offenen, graphischen Anmutung sorgt REFLEX<sup>2</sup> Table auf Tisch, Sideboard oder Boden für intensives, nach unten gerichtetes Licht. Aus einer geometrischen Rahmenstruktur entsteht so eine angenehme und atmosphärische Lichtstimmung im Raum.



REFLEX<sup>2</sup> Table extends the product family with a fine, filigree table luminaire. With its open, graphic appearance, REFLEX<sup>2</sup> Table provides intense downward light on a table, sideboard or floor, creating a pleasant and atmospheric lighting mood from a geometric frame structure.

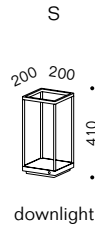

<b>Licht</b> light	<b>nach unten gestreut</b> scattered downwards
<b>Leuchtmittel</b> lamp	LED 33 W, CRI Ra>90 (R9>50) Dim2Warm, EEK/EEC E
<b>Material</b> material	<b>Leuchtmittelabdeckungen: Flachglas satinée</b> lamp cover: glass semigloss
<b>Gehäuse</b> housing	<b>Aluminium schwarz oder weiß beschichtet</b> aluminium black or white coated
<b>Sonstiges</b> features	<b>LED austauschbar; Kabelaufwicklung unter dem Sockel; Taster für on/off/dimming im Sockel</b> LED exchangeable; cable wrap below the base; push button for on/off/dimming in the base

## REFLEX<sup>2</sup> Table S

Abbildung figure	Beschreibung description	Leuchtmittel lamp	Regelung control	Leistung power	CCT	Lumen lumen	Art.-Nr. art.-no.	€ netto DE excl. VAT	€ brutto DE incl. VAT
●	<b>schwarz</b> black	LED	integr.	33 W	2200–3000 K D2W	3910 lm	RE3801	487,39 €	580,00 €
○	<b>weiß</b> white	LED	integr.	33 W	2200–3000 K D2W	3910 lm	RE3802	487,39 €	580,00 €

## SLICE<sup>2</sup> Furniture

Der komplett geschlossene Leuchtenkopf von SLICE<sup>2</sup> sorgt mit einer besonders innovativen Anordnung der Leuchtmittel auf zwei Ebenen für eine optimale Lichtwirkung: Breit nach oben abstrahlende LED-Streifen bieten indirektes, auch bei voller Leistung absolut blendfreies Licht. Nach unten sorgen LED-Leuchtmittel, deren Licht über die Glaskanten eingespeist und von einer prismatischen Scheibe verteilt wird, für ideales, direktes Licht auf der Arbeitsfläche.

The completely closed luminaire head of SLICE<sup>2</sup> with its particularly innovative arrangement of illuminants on two levels creates an optimum light effect: Wide-angled upwards-facing LED strips provide indirect light that is entirely glare-free even at full power. Downwards, LEDs whose light is supplied via the glass edges and distributed by a prismatic disk generate ideal direct lighting for work surfaces.

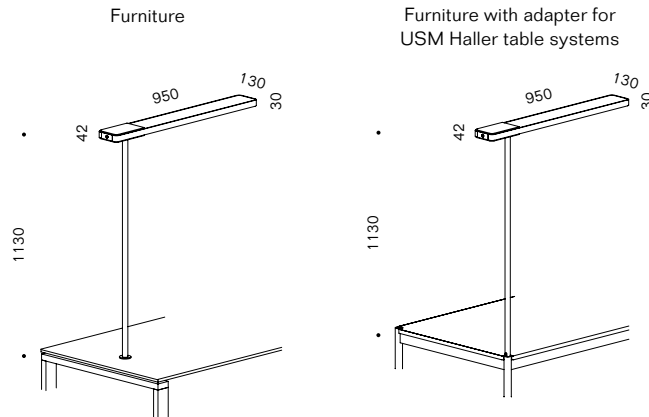

<b>Licht</b> light	<b>direkt nach oben abstrahlend durch Diffusorplatte, nach unten abgeblendet durch Prismenstrukturglas; vereinheitlichte Blendungsbewertung UGR&lt;15, Lichtverteilung: indirekt 85%, direkt 15%</b> beaming upwards through diffuser plate, downwards directed through prism pattern glass; unified glare rating UGR<15, light distribution LED: indirect 85%, direct 15%
<b>Leuchtmittel</b> lamp	LED 2 × 41 W, CRI Ra>80, EEK/EEC C
<b>Material</b> material	<b>Leuchtenkopf und Leuchtenrohr: glanzverchromt, schwarz, weiß oder silber beschichtet; Leuchtmittelabdeckung: unten Prismenstruktur-Acrylglas, oben Acrylglas Diffusor</b> lamp head and tube: chrome-plated, black, white or silver coated; lamp cover: bottom prism pattern acrylic glass, top diffuser acrylic glass
<b>Sonstiges</b> features	<b>LED austauschbar; vereinheitlichte Blendungsbewertung UGR&lt;15; weitere Ausführungen (CCT/CRI/Leistung) möglich</b> LED exchangeable; unified glare rating UGR<15; other technical versions (CCT/CRI/power) on request



## SLICE<sup>2</sup> Furniture

Abbildung figure	Beschreibung description	Leuchtmittel lamp	Regelung control	Leistung power	CCT	Lumen lumen	Art.-Nr. art.-no.	€ netto DE excl. VAT	€ brutto DE incl. VAT
●	glanzverchromt chrome plated	LED	integr.	82 W	3000 K	12710 lm	SL4001	1.336,13 €	1.590,00 €
					4000 K	13345 lm	SL4002	1.336,13 €	1.590,00 €
			Sensorik	82 W	3000 K	12710 lm	SL5001	1.504,20 €	1.790,00 €
					4000 K	13345 lm	SL5002	1.504,20 €	1.790,00 €
●	schwarz black	LED	integr.	82 W	3000 K	12710 lm	SL4101	1.252,10 €	1.490,00 €
					4000 K	13345 lm	SL4102	1.252,10 €	1.490,00 €
			Sensorik	82 W	3000 K	12710 lm	SL5101	1.420,17 €	1.690,00 €
					4000 K	13345 lm	SL5102	1.420,17 €	1.690,00 €
○	weiß white	LED	integr.	82 W	3000 K	12710 lm	SL4201	1.252,10 €	1.490,00 €
					4000 K	13345 lm	SL4202	1.252,10 €	1.490,00 €
			Sensorik	82 W	3000 K	12710 lm	SL5201	1.420,17 €	1.690,00 €
					4000 K	13345 lm	SL5202	1.420,17 €	1.690,00 €
●	silber silver	LED	integr.	82 W	3000 K	12710 lm	SL4301	1.252,10 €	1.490,00 €
					4000 K	13345 lm	SL4302	1.252,10 €	1.490,00 €
			Sensorik	82 W	3000 K	12710 lm	SL5301	1.420,17 €	1.690,00 €
					4000 K	13345 lm	SL5302	1.420,17 €	1.690,00 €

## SLICE<sup>2</sup> Furniture with adapter for USM Haller table systems

Abbildung figure	Beschreibung description	Leuchtmittel lamp	Regelung control	Leistung power	CCT	Lumen lumen	Art.-Nr. art.-no.	€ netto DE excl. VAT	€ brutto DE incl. VAT
●	glanzverchromt chrome plated	LED	integr.	82 W	3000 K	12710 lm	SL4011	1.336,13 €	1.590,00 €
					4000 K	13345 lm	SL4012	1.336,13 €	1.590,00 €
			Sensorik	82 W	3000 K	12710 lm	SL5011	1.504,20 €	1.790,00 €
					4000 K	13345 lm	SL5012	1.504,20 €	1.790,00 €
●	schwarz black	LED	integr.	82 W	3000 K	12710 lm	SL4111	1.252,10 €	1.490,00 €
					4000 K	13345 lm	SL4112	1.252,10 €	1.490,00 €
			Sensorik	82 W	3000 K	12710 lm	SL5111	1.420,17 €	1.690,00 €
					4000 K	13345 lm	SL5112	1.420,17 €	1.690,00 €
○	weiß white	LED	integr.	82 W	3000 K	12710 lm	SL4211	1.252,10 €	1.490,00 €
					4000 K	13345 lm	SL4212	1.252,10 €	1.490,00 €
			Sensorik	82 W	3000 K	12710 lm	SL5211	1.420,17 €	1.690,00 €
					4000 K	13345 lm	SL5212	1.420,17 €	1.690,00 €
●	silber silver	LED	integr.	82 W	3000 K	12710 lm	SL4311	1.252,10 €	1.490,00 €
					4000 K	13345 lm	SL4312	1.252,10 €	1.490,00 €
			Sensorik	82 W	3000 K	12710 lm	SL5311	1.420,17 €	1.690,00 €
					4000 K	13345 lm	SL5312	1.420,17 €	1.690,00 €





TABLE





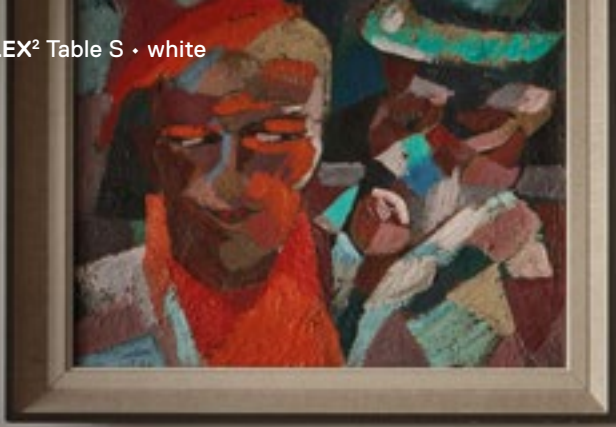



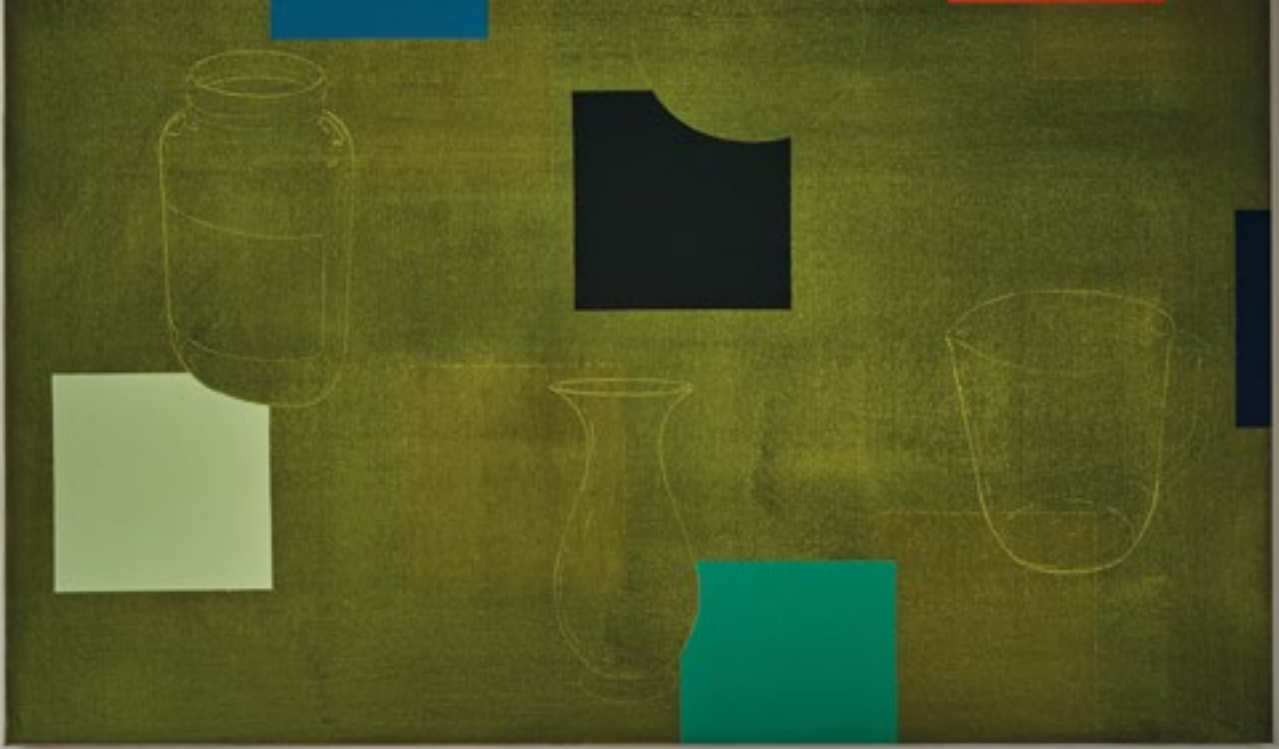







TABLE





**CLUB**  
S. 169



**JONES**  
S. 171



**POPPY**  
S. 172

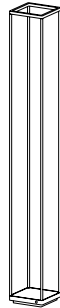

**REFLEX²**  
S. 174

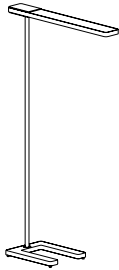

**SLICE²**  
S. 176





## CLUB Floor

Diese Familie zeitlos klassischer Schirmleuchten ist für den anspruchsvollen Bedarf optimiert. Statt eines Drahtgestells halten schlanke Aluminiumprofile die nahtlosen Schirmhälften – und vermeiden unschöne Schattenkanten. An den seitlichen Knöpfen ist ihr freundlich-atmosphärisches Licht im oberen und unteren Bereich getrennt zu regeln. Und überflüssiges Kabel wird im Fuß aufgewickelt.

This family of timelessly classical lamps with shades has been improved to satisfy sophisticated demands. Instead of a wire frame, slender aluminum profiles hold the seamless halves of the shade, avoiding unsightly shadow lines. Its friendly, atmospheric light can be regulated separately on the upper and lower section by means of the control knobs on the side. And any superfluous cable is wound up in the light unit.

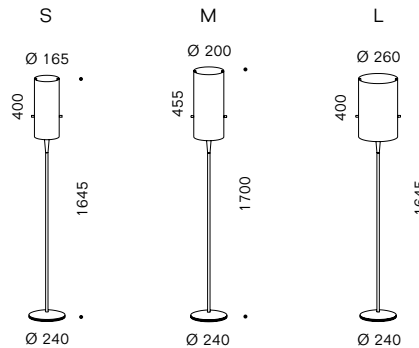





<b>Licht</b> light	<b>nach oben und unten direkt, gerichtet, diffus durch Schirm</b> directly up- and downwards, directional, diffuse through shade
<b>Leuchtmittel</b> lamp	LED up 1 x 10 W CoB, down 2 x 5 W CoB, CRI Ra>97 (R9>93) EEK/EEC F
<b>Material</b> material	<b>Aluminium gebürstet oder schwarz lackiert; Schirm: Chintz weiß oder Melange grau</b> aluminium brushed or black laquered; shade: chintz white or melange grey
<b>Sonstiges</b> features	<b>LED austauschbar; über Tastknöpfe am Schirm getrennt regelbar (on/off/dimmen)</b> LED exchangeable; controlled separately (on/off/dimming) via push buttons on the shade





## CLUB Floor S

Abbildung figure	Beschreibung description	Leuchtmittel lamp	Regelung control	Leistung power	CCT	Lumen lumen	Art.-Nr. art.-no.	€ netto DE excl. VAT	€ brutto DE incl. VAT
	<b>gebürstet, Chintz weiß</b> brushed, Chintz white	LED	integr.	20 W	2700 K	1930 lm	CL2101	806,72 €	960,00 €
	<b>schwarz, Chintz weiß</b> black, Chintz white	LED	integr.	20 W	2700 K	1930 lm	CL2102	806,72 €	960,00 €
	<b>gebürstet, Melange grau</b> brushed, Melange grey	LED	integr.	20 W	2700 K	1930 lm	CL2103	806,72 €	960,00 €
	<b>schwarz, Melange grau</b> black, Melange grey	LED	integr.	20 W	2700 K	1930 lm	CL2104	806,72 €	960,00 €

## CLUB Floor M

Abbildung figure	Beschreibung description	Leuchtmittel lamp	Regelung control	Leistung power	CCT	Lumen lumen	Art.-Nr. art.-no.	€ netto DE excl. VAT	€ brutto DE incl. VAT
	<b>gebürstet, Chintz weiß</b> brushed, Chintz white	LED	integr.	20 W	2700 K	1930 lm	CL2111	806,72 €	960,00 €
	<b>schwarz, Chintz weiß</b> black, Chintz white	LED	integr.	20 W	2700 K	1930 lm	CL2112	806,72 €	960,00 €
	<b>gebürstet, Melange grau</b> brushed, Melange grey	LED	integr.	20 W	2700 K	1930 lm	CL2113	806,72 €	960,00 €
	<b>schwarz, Melange grau</b> black, Melange grey	LED	integr.	20 W	2700 K	1930 lm	CL2114	806,72 €	960,00 €

## CLUB Floor L

Abbildung figure	Beschreibung description	Leuchtmittel lamp	Regelung control	Leistung power	CCT	Lumen lumen	Art.-Nr. art.-no.	€ netto DE excl. VAT	€ brutto DE incl. VAT
	<b>gebürstet, Chintz weiß</b> brushed, Chintz white	LED	integr.	20 W	2700 K	1930 lm	CL2121	806,72 €	960,00 €
	<b>schwarz, Chintz weiß</b> black, Chintz white	LED	integr.	20 W	2700 K	1930 lm	CL2122	806,72 €	960,00 €
	<b>gebürstet, Melange grau</b> brushed, Melange grey	LED	integr.	20 W	2700 K	1930 lm	CL2123	806,72 €	960,00 €
	<b>schwarz, Melange grau</b> black, Melange grey	LED	integr.	20 W	2700 K	1930 lm	CL2124	806,72 €	960,00 €

## JONES Floor

Diese diskrete Dame wird auf den ersten Blick gern unterschätzt. JONES ist kräftiger Deckenfluter, intime Leseleuchte und atmosphärische Schirmleuchte in einer Gestalt. Ihre Verwandlung funktioniert ganz einfach über zwei Knöpfe am Standrohr der Leuchte, ein dritter regelt die Helligkeit. Und mit dem farbigen Glaseinsatz leuchtet der weiße Schirm –erhältlich in zwei Größen–auf Wunsch farbig.



At first sight this discreet lady is often underestimated. JONES is a powerful uplight, intimate reading light and atmospheric shade lamp in one. It is transformed extremely easily by means of two buttons on the lamp' upright tube, while a third regulates the brightness. And if desired, a coloured glass insert causes the white shade, which is available in two sizes, to shine in colour.

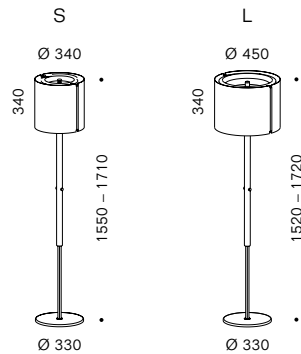

<b>Licht</b> light	<b>stufenlos einstellbar: Leselicht, gerichtet nach unten. Dekoratives Licht, gerichtet nach unten und oben, rundum diffus durch Schirm (farbig durch Glaseinsatz) Indirektes Licht, gerichtet nach oben</b> Infinitely adjustable: reading light, directed downwards. Decorative light, directed downwards and upwards, diffused all around by shade (coloured by glass insert). Indirect light, directed upwards.
<b>Leuchtmittel</b> lamp	LED 38 W CoB, CRI Ra>97 (R9>90), EEK/EEC F E27 max. 205 W, EEK/EEC G (Lieferung ohne Leuchtmittel/delivery without bulb)
<b>Material</b> material	<b>Schirm: Glashartgewebe textilkaschiert weiß. Rundrohr und Sockel: Aluminium gebürstet und schutzlackiert oder schwarz lackiert Vierkantrrohr: Aluminium verchromt. Glaseinsatz: Borosilikatglas orange</b> shade: glass fabric laminated, white; round rod and base: aluminum brushed with protective coating or laquered black square rod: aluminum chrome-plated; colored glass insert: borosilicate glass orange
<b>Sonstiges</b> features	<b>LED austauschbar; farbiger Glaseinsatz leicht und schnell einsetzbar; Taster für on/off/dimming im Standrohr</b> LED exchangeable; colored glass insert easily replaceable; push buttons für on/off/dimming in the standpipe

## JONES Floor S

Abbildung figure	Beschreibung description	Leuchtmittel lamp	Regelung control	Leistung power	CCT	Lumen lumen	Art.-Nr. art.-no.	€ netto DE excl. VAT	€ brutto DE incl. VAT
●	<b>gebürstet</b> brushed	LED	integr.	38 W	2700 K	3500 lm	JO3006	1.672,27 €	1.990,00 €
		E27	integr.	max. 205 W	3000 K	4200 lm	JO1010	1.252,10 €	1.490,00 €
●	<b>schwarz</b> black	LED	integr.	38 W	2700 K	3500 lm	JO3106	1.672,27 €	1.990,00 €

## JONES Floor L

Abbildung figure	Beschreibung description	Leuchtmittel lamp	Regelung control	Leistung power	CCT	Lumen lumen	Art.-Nr. art.-no.	€ netto DE excl. VAT	€ brutto DE incl. VAT
●	<b>gebürstet</b> brushed	LED	integr.	38 W	2700 K	3500 lm	JO3003	1.672,27 €	1.990,00 €
		E27	integr.	max. 205 W	3000 K	4200 lm	JO1007	1.252,10 €	1.490,00 €
●	<b>schwarz</b> black	LED	integr.	38 W	2700 K	3500 lm	JO3103	1.672,27 €	1.990,00 €

## POPPY Floor

Werden die „Mohnblüten“ dieser Familie durch Einschalten geweckt, öffnen sich ihre Schirme ganz allmählich: die feinen Blätter sind aus Bimetall und dehnen sich durch Erwärmung aus. Alle Varianten können nach Belieben umgestaltet werden. Der flexible, textilmantelte Schlauch lässt sich immer neu biegen – zur Änderung der Lichtrichtung, oder einfach weil Ihnen danach ist. Die mundgeblasenen Glaskapseln sind erhältlich in den Farben keramik, rubinrot oder violett.

When the “poppy flowers” in this family are woken by the lamp being switched on, their shades open very gradually: the delicate leaves are bi-metallic and expand when heated. All the versions can be reshaped as desired. The flexible, textile-coated stem can be bent at will, to change the direction of the light, or because you just feel like it. The hand-blown glass capsules are available in the colours ceramic, ruby red or violet.

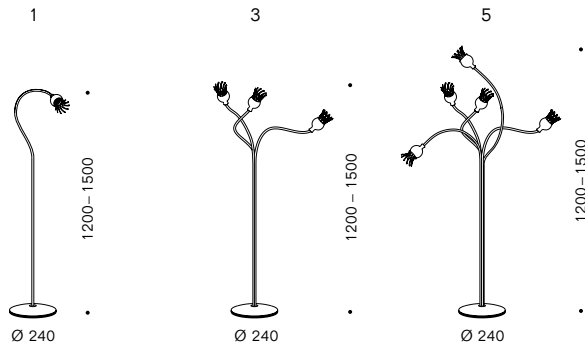

**Licht**  
light **nach vorne gerichtet, seitlich abgeschirmt**  
directed forward, shielded to the sides

**Leuchtmittel**  
lamp **POPPY Floor 1/3: 1 x/3 x G4 35 W, 12 V, EEK/EEC G**  
**POPPY Floor 5: 5 x G4 20 W, 12 V, EEK/EEC G**







**Material**  
material **Arme, flexibel: Aluminium, textilmantelt beige oder schwarz;**  
**Glasschirme: mundgeblasenes Glas keramik, rubinrot oder violett; Lamellen: Bimetall; Sockel: Stahl**  
arms: flexible, textile coated aluminium tube in beige or black; glass shade: hand-blown glass in ceramic, ruby red or violet; lamellae: bimetal; base: steel

**Sonstiges**  
features **Leuchtmittel in Lieferung enthalten; Reflektor-Lamellen öffnen sich nach ca. 2 Minuten Betriebszeit**  
lamps included in delivery; lamellae open within approx. 2 minutes after switching on luminaire







## POPPY Floor 1

Abbildung figure	Beschreibung description	Fassung lamp	Regelung control	Leistung power	Art.-Nr. art.-no.	€ netto DE excl. VAT	€ brutto DE incl. VAT
	<b>1 Arm schwarz, Schirm keramik</b> 1 arm black, shade ceramic	G4	ON/OFF	35 W	PO1052	495,80 €	590,00 €
	<b>1 Arm schwarz, Schirm rubinrot</b> 1 arm black, shade red	G4	ON/OFF	35 W	PO1051	495,80 €	590,00 €
	<b>1 Arm schwarz, Schirm violett</b> 1 arm black, shade violet	G4	ON/OFF	35 W	PO1050	495,80 €	590,00 €
	<b>1 Arm beige, Schirm keramik</b> 1 arm beige shade ceramic	G4	ON/OFF	35 W	PO1055	495,80 €	590,00 €
	<b>1 Arm beige, Schirm rubinrot</b> 1 arm beige shade red	G4	ON/OFF	35 W	PO1054	495,80 €	590,00 €
	<b>1 Arm beige, Schirm violett</b> 1 arm beige shade violet	G4	ON/OFF	35 W	PO1053	495,80 €	590,00 €

## POPPY Floor 3

Abbildung figure	Beschreibung description	Fassung lamp	Regelung control	Leistung power	Art.-Nr. art.-no.	€ netto DE excl. VAT	€ brutto DE incl. VAT
	<b>3 Arme schwarz, Schirme keramik</b> 3 arms black, shades ceramic	3 × G4	ON/OFF	105 W	PO1058	689,08 €	820,00 €
	<b>3 Arme schwarz, Schirme rubinrot</b> 3 arms black, shades red	3 × G4	ON/OFF	105 W	PO1057	689,08 €	820,00 €
	<b>3 Arme schwarz, Schirme violett</b> 3 arms black, shades violet	3 × G4	ON/OFF	105 W	PO1056	689,08 €	820,00 €
	<b>3 Arme beige, Schirme keramik</b> 3 arms beige shades ceramic	3 × G4	ON/OFF	105 W	PO1061	689,08 €	820,00 €
	<b>3 Arme beige, Schirme rubinrot</b> 3 arms beige shades red	3 × G4	ON/OFF	105 W	PO1060	689,08 €	820,00 €
	<b>3 Arme beige, Schirme violett</b> 3 arms beige shades violet	3 × G4	ON/OFF	105 W	PO1059	689,08 €	820,00 €

## POPPY Floor 5

Abbildung figure	Beschreibung description	Fassung lamp	Regelung control	Leistung power	Art.-Nr. art.-no.	€ netto DE excl. VAT	€ brutto DE incl. VAT
	<b>5 Arme schwarz, Schirme keramik</b> 5 arms black, shades ceramic	5 × G4	ON/OFF	100 W	PO1064	873,95 €	1.040,00 €
	<b>5 Arme schwarz, Schirme rubinrot</b> 5 arms black, shades red	5 × G4	ON/OFF	100 W	PO1063	873,95 €	1.040,00 €
	<b>5 Arme schwarz, Schirme violett</b> 5 arms black, shades violet	5 × G4	ON/OFF	100 W	PO1062	873,95 €	1.040,00 €
	<b>5 Arme beige, Schirme keramik</b> 5 arms beige shades ceramic	5 × G4	ON/OFF	100 W	PO1067	873,95 €	1.040,00 €
	<b>5 Arme beige, Schirme rubinrot</b> 5 arms beige shades red	5 × G4	ON/OFF	100 W	PO1066	873,95 €	1.040,00 €
	<b>5 Arme beige, Schirme violett</b> 5 arms beige shades violet	5 × G4	ON/OFF	100 W	PO1065	873,95 €	1.040,00 €



## REFLEX<sup>2</sup> Floor

Die Stehleuchten der REFLEX<sup>2</sup>-Produktfamilie scheinen mit Ihren schwarzen oder weißen Linien lediglich die Konturen eines Quaders nachzuzeichnen. Alle Modelle besitzen eine feine, elegant abgerundete Rahmenstruktur, in der sich die LED-Platinen befinden. Die Deckenfluter strahlen absolut blendfreies Licht über die Decke in den Raum, wohingegen die Leseleuchte sanft, aber intensiv nach unten leuchtet. Aus einer dezenten Struktur entsteht so eine intensive Lichtstimmung. Gesteuert wird das Licht über Taster im Sockel, die beim Modell M zusätzlich zur Helligkeit auch die Lichtfarbe regeln.

The floor luminaires of the REFLEX<sup>2</sup> family with their black or white lines seem to merely trace the contours of a cuboid. All models have a fine, elegantly rounded framework structure, which contains the LED circuit boards. The ceiling washlights radiate absolutely glare-free light into the room via the ceiling, whereas the reading luminaire provides a soft but intense downward light. A subtle structure that creates an intense lighting atmosphere in the room. The light is controlled via push-buttons in the base, which in the case of the M model not only regulate brightness but also light color.

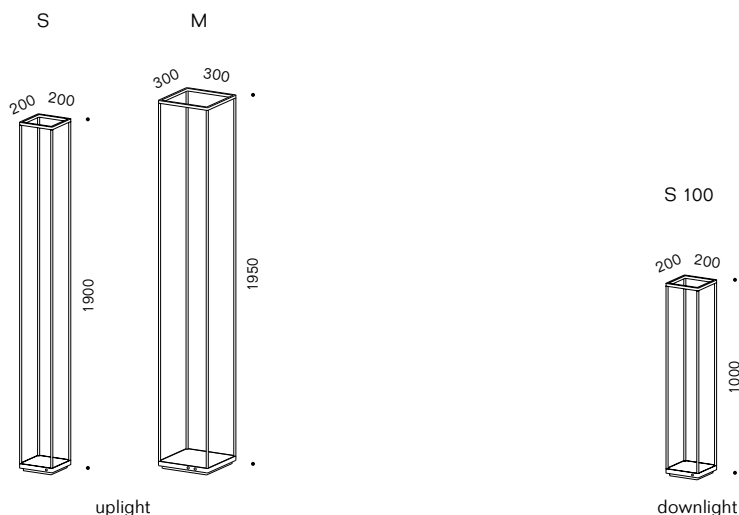

<b>Licht</b> light	<b>nach oben gestreut, indirekt über Decke</b> scattered upwards, diffuse all around via ceiling	<b>nach unten gestreut</b> scattered downwards
<b>Leuchtmittel</b> lamp	LED 35–50 W, CRI Ra>90 (R9>50); S: Dim2Warm, M: 2200–4000 K/tunable white; EEK/EEC E	LED 33 W, CRI Ra>90 (R9>50) Dim2Warm, EEK/EEC E
<b>Material</b> material	<b>Leuchtmittelabdeckungen: Flachglas satinée</b> lamp cover: glass semigloss	
<b>Gehäuse</b> housing	<b>Aluminium schwarz oder weiß beschichtet</b> aluminium black or white coated	
<b>Sonstiges</b> features	LED austauschbar; Kabelaufwicklung unter dem Sockel; Fusstaster für on/off/dimming (S, M) und Colour dimming (M) im Sockel LED exchangeable; Cable wrap below base; push buttons for on/off/dimming (S, M) and colour dimming (M) in the base	



## REFLEX<sup>2</sup> Floor S

Abbildung figure	Beschreibung description	Leuchtmittel lamp	Regelung control	Leistung power	CCT	Lumen lumen	Art.-Nr. art.-no.	€ netto DE excl. VAT	€ brutto DE incl. VAT
●	<b>schwarz</b> black	LED	integr.	33 W	2200–3000 K D2W	3910 lm	RE3501	823,53 €	980,00 €
○	<b>weiß</b> white	LED	integr.	33 W	2200–3000 K D2W	3910 lm	RE3502	823,53 €	980,00 €

## REFLEX<sup>2</sup> Floor M

Abbildung figure	Beschreibung description	Leuchtmittel lamp	Regelung control	Leistung power	CCT	Lumen lumen	Art.-Nr. art.-no.	€ netto DE excl. VAT	€ brutto DE incl. VAT
●	<b>schwarz</b> black	LED	integr.	50 W	2200–4000 K TW	6040 lm	RE3603	1.058,82 €	1.260,00 €
○	<b>weiß</b> white	LED	integr.	50 W	2200–4000 K TW	6040 lm	RE3604	1.058,82 €	1.260,00 €

## REFLEX<sup>2</sup> Floor S 100

Abbildung figure	Beschreibung description	Leuchtmittel lamp	Regelung control	Leistung power	CCT	Lumen lumen	Art.-Nr. art.-no.	€ netto DE excl. VAT	€ brutto DE incl. VAT
●	<b>schwarz</b> black	LED	integr.	33 W	2200–3000 K D2W	3910 lm	RE3701	571,43 €	680,00 €
○	<b>weiß</b> white	LED	integr.	33 W	2200–3000 K D2W	3910 lm	RE3702	571,43 €	680,00 €

## SLICE<sup>2</sup> Floor

SLICE<sup>2</sup> entwickelt die erfolgreiche SLICE technisch, funktional und formalästhetisch weiter. Der komplett geschlossene Leuchtenkopf sorgt mit einer besonders innovativen Anordnung der Leuchtmittel auf zwei Ebenen für eine optimale Lichtwirkung: Breit nach oben abstrahlende LED-Streifen bieten indirektes, auch bei voller Leistung absolut blendfreies Licht. Nach unten sorgen LED-Leuchtmittel, deren Licht über die Glaskanten eingespeist und von einer prismatischen Scheibe verteilt wird, für ideales, direktes Licht auf der Arbeitsfläche.

SLICE<sup>2</sup> further develops the successful SLICE with a view to technology, functionality and formal aesthetics. The completely closed luminaire head with its particularly innovative arrangement of illuminants on two levels creates an optimum light effect: Wide-angled upwards-facing LED strips provide indirect light that is entirely glare-free even at full power. Downwards, LEDs whose light is supplied via the glass edges and distributed by a prismatic disk generate ideal direct lighting for work surfaces.

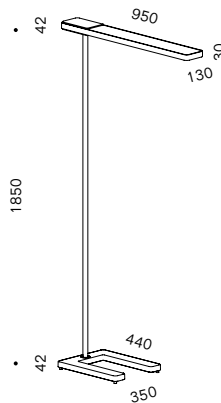

<b>Licht</b> light	<b>direkt nach oben abstrahlend durch Diffusorplatte, nach unten abgeblendet durch Prismenstrukturglas; vereinheitlichte Blendungsbewertung UGR&lt;15, Lichtverteilung: indirekt 85%, direkt 15%</b> beaming upwards through diffuser plate, downwards directed through prism pattern glass; unified glare rating UGR<15, light distribution: indirect 85%, direct 15%
<b>Leuchtmittel</b> lamp	LED 2×41 W, CRI Ra>80, EEK/EEC C
<b>Material</b> material	<b>Leuchtenkopf, Leuchtenrohr und Sockel: Aluminium glanzverchromt (außer Sockel), schwarz, weiß oder silberbeschichtet; Leuchtmittelabdeckung: unten Prismenstruktur-Acrylglas, oben Acrylglas Diffusor</b> lamp head, tube and light unit: aluminium chrome-plated (except base), black, white or silver coated; lamp cover: down prism pattern acrylic glass, top diffuser acrylic glass
<b>Sonstiges</b> features	<b>LED austauschbar; weitere Ausführungen (CCT/CRI/Leistung) möglich</b> LED exchangeable; other technical versions (CCT/CRI/power) on request

## SLICE<sup>2</sup> Floor

Abbildung figure	Beschreibung description	Leuchtmittel lamp	Regelung control	Leistung power	CCT	Lumen lumen	Art.-Nr. art.-no.	€ netto DE excl. VAT	€ brutto DE incl. VAT
●	<b>glanzverchromt, Sockel silber</b> chrome plated, base silver	LED	integr.	82 W	3000 K	12570 lm	SL2001	1.504,20 €	1.790,00 €
					4000 K	13320 lm	SL2002	1.504,20 €	1.790,00 €
●	<b>schwarz</b> black	LED	integr.	82 W	3000 K	12570 lm	SL2101	1.420,17 €	1.690,00 €
					4000 K	13320 lm	SL2102	1.420,17 €	1.690,00 €
○	<b>weiß</b> white	LED	integr.	82 W	3000 K	12570 lm	SL2201	1.420,17 €	1.690,00 €
					4000 K	13320 lm	SL2202	1.420,17 €	1.690,00 €
●	<b>silber</b> silver	LED	integr.	82 W	3000 K	12570 lm	SL2301	1.420,17 €	1.690,00 €
					4000 K	13320 lm	SL2302	1.420,17 €	1.690,00 €

## SLICE<sup>2</sup> Floor Sensorik

Abbildung figure	Beschreibung description	Leuchtmittel lamp	Regelung control	Leistung power	CCT	Lumen lumen	Art.-Nr. art.-no.	€ netto DE excl. VAT	€ brutto DE incl. VAT
●	<b>glanzverchromt, Sockel silber</b> chrome plated, base silver	LED	Sensorik	82 W	3000 K	12570 lm	SL3001	1.672,27 €	1.990,00 €
					4000 K	13320 lm	SL3002	1.672,27 €	1.990,00 €
●	<b>schwarz</b> black	LED	Sensorik	82 W	3000 K	12570 lm	SL3101	1.588,24 €	1.890,00 €
					4000 K	13320 lm	SL3102	1.588,24 €	1.890,00 €
○	<b>weiß</b> white	LED	Sensorik	82 W	3000 K	12570 lm	SL3201	1.588,24 €	1.890,00 €
					4000 K	13320 lm	SL3202	1.588,24 €	1.890,00 €
●	<b>silber</b> silver	LED	Sensorik	82 W	3000 K	12570 lm	SL3301	1.588,24 €	1.890,00 €
					4000 K	13320 lm	SL3302	1.588,24 €	1.890,00 €







FLOOR







FLOOR







FLOOR





THE  
SUN  
IS  
GONE  
BUT  
WE  
HAVE  
THE  
LIGHT









FLOOR











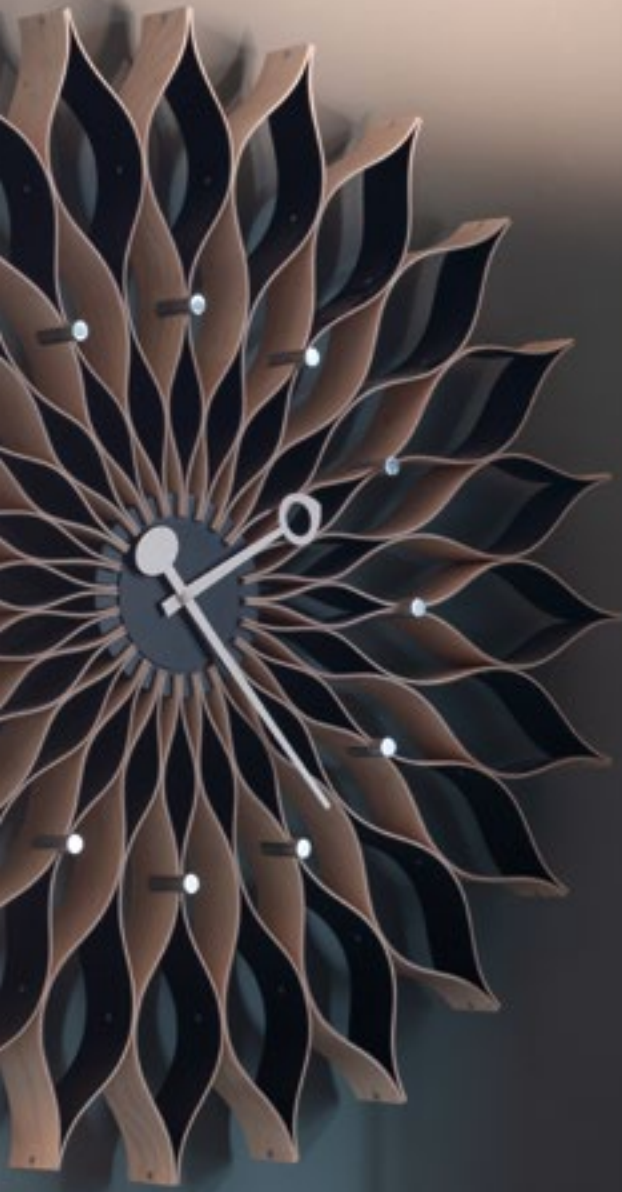















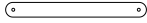

**BALDACHINPROFIL 2**  
**CANOPY PROFILE 2**  
S. 198

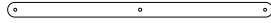

**BALDACHINPROFIL 3**  
**CANOPY PROFILE 3**  
S. 199

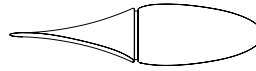

**ERSATZBEZUG**  
**REPLACEMENT COVER**  
S. 200



**KRISTALLGLAS ANHÄNGER**  
**CRYSTAL GLAS PENDANT**  
S. 200



**OPTIKEN**  
**OPTICS**  
S. 201



**SPIEGEL ADAPTER SET**  
**MIRROR ADAPTER SET**  
S. 201



**WANDADAPTER**  
**WALL COVER**  
S. 202

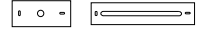

**WANDABDECKUNGEN**  
**WALL COVER**  
S. 203

## BALDACHINPROFIL 2 / CANOPY PROFILE 2

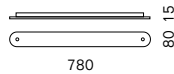

**Material** Aluminium gebürstet oder poliert, schwarz oder weiß lackiert  
**material** aluminium brushed or polished, black or white coated

**Passend für** CAVITY Suspension L; CURLING Suspension Rope/Tube S, M, L;  
**Suitable for** DRAFT Suspension Rope/Tube S, M; DRUM Suspension Rope/Tube S, M; REEF Suspension 1

Abbildung figure	Beschreibung description	Art.-Nr. art.-no.	€ netto DE excl. VAT	€ brutto DE incl. VAT
●	<b>gebürstet</b> brushed	BP1001	268,91 €	320,00 €
●	<b>poliert</b> polished	BP1002	294,12 €	350,00 €
●	<b>schwarz</b> black	BP1009	268,91 €	320,00 €
○	<b>weiß</b> white	BP1010	268,91 €	320,00 €



DRAFT Suspension Rope M

### Maße measurements

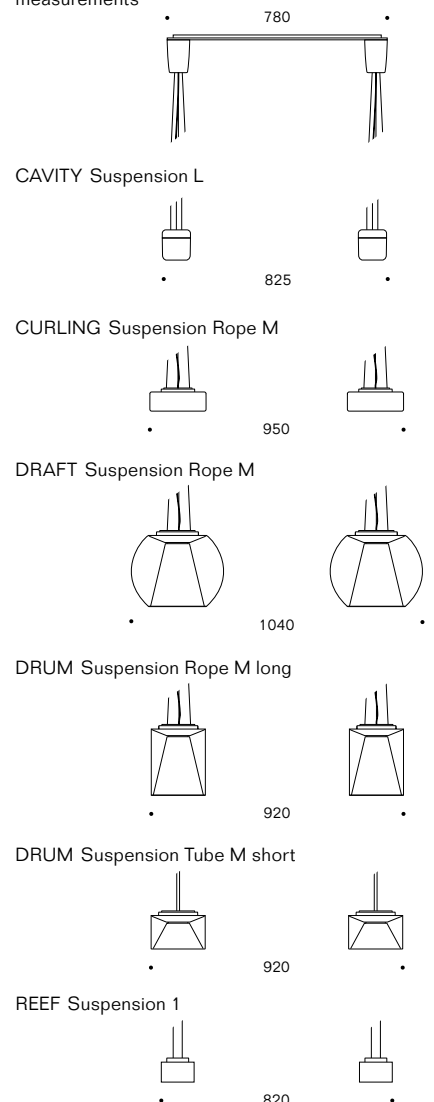



# BALDACHINPROFIL 3 / CANOPY PROFILE 3

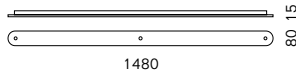

**Material** Aluminium gebürstet oder poliert, schwarz oder weiß lackiert  
**material** aluminium brushed or polished, black or white coated

**Passend für** CAVITY Suspension L; CURLING Suspension Rope/Tube S, M, L;  
**Suitable for** DRAFT Suspension Rope/Tube S, M; DRUM Suspension Rope/Tube S, M; REEF Suspension 1

Abbildung figure	Beschreibung description	Art.-Nr. art.-no.	€ netto DE excl. VAT	€ brutto DE incl. VAT
	<b>gebürstet</b> brushed	BP1004	344,54 €	410,00 €
	<b>poliert</b> polished	BP1005	378,15 €	450,00 €
	<b>schwarz</b> black	BP1013	344,54 €	410,00 €
	<b>weiß</b> white	BP1014	344,54 €	410,00 €

**Maße**  
measurement

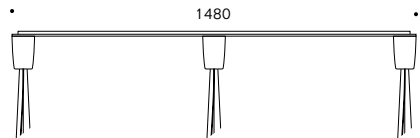

CAVITY Suspension L

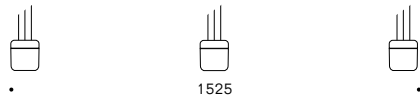

CAVITY Suspension L

CURLING Suspension Rope M

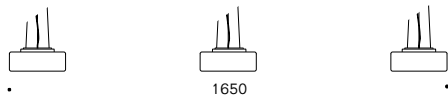

CURLING / DRAFT / DRUM  
Suspension Tube / Rope M

DRAFT Suspension Rope M

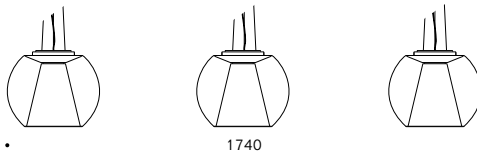

DRUM Suspension Rope M long

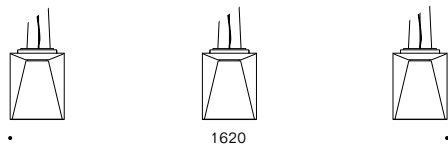

DRUM Suspension Tube M short

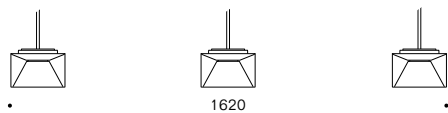

REEF Suspension 1

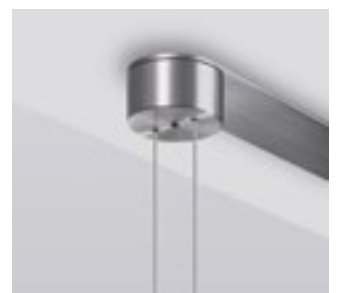
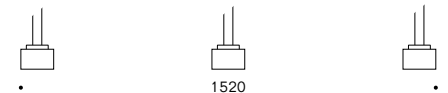

REEF Suspension

## ERSATZBEZUG / REPLACEMENT COVER

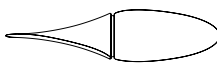

**Material**  
material **Stoffbezug weiß aus 80% Polyamid und 20% Elasthan**  
cover white made of 80% polyamide and 20% elastane

**Sonstiges**  
features **werkzeuglose Montage über Federstahldraht**  
mounting tool-free to spring steel wire

**Passend für**  
Suitable for PROPELLER

Abbildung figure	Beschreibung description	Art.-Nr. art.-no.	€ netto DE excl. VAT	€ brutto DE incl. VAT
○	<b>weiß</b> white	PR1004	92,44 €	110,00 €

## KRISTALLGLAS ANHÄNGER / CRYSTAL GLAS PENDANT



**Material**  
material **mehrgliedrige Anhänger: 3 Octagon-Elemente mit 1 Eiszapfen-Element aus geschliffenem Kristallglas,**  
**ZOOM Anhänger ca. 60 mm, ZOOM XL Anhänger ca. 100 mm**  
polynomial pendant: 3 octagon elements with 1 icicle made of edged crystal glass, ZOOM pendant approx.  
60 mm, ZOOM XL pendant approx. 100 mm

**Sonstiges**  
features **werkzeuglose Montage durch Einhängen in die unteren Scherengitterdrehpunkte**  
simple mounting by hooking in lower snake fence's pivot points

**Passend für**  
Suitable for ZOOM, ZOOM XL

Abbildung figure	Beschreibung description	Art.-Nr. art.-no.	€ netto DE excl. VAT	€ brutto DE incl. VAT
○	<b>ZOOM Kristallglas Set (20 Stk.)</b> ZOOM Kristallglas Set (20 pcs.)	ZO1014	163,87 €	195,00 €
○	<b>ZOOM XL Kristallglas Set (20 Stk.)</b> ZOOM XL Kristallglas Set (20 pcs.)	ZO1015	331,93 €	395,00 €

## OPTIKEN / OPTICS

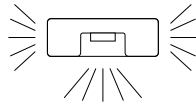

Diffusorscheibe (enthalten)  
diffuser (included)

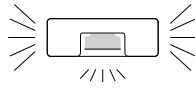

abgeblendet/deglared  
CU8535

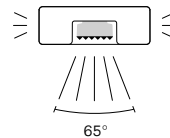

microprismatic  
CU8536

### Optiken optics

Mit den einfach austauschbaren Optiken haben Sie die Möglichkeit, die Lichtverteilung der CURLING zu steuern: In Lieferung enthalten ist eine Echtglas-Streuscheibe für gleichmäßiges, weiches Direkt- und Raumlicht. Optional erhältlich sind eine Entblendungs-Optik für viel Raumlicht und starke Direktlichtentblendung oder eine Mikroprismatik-Optik für gerichtetes Direktlicht im Abstrahlwinkel von 65°.

With the easily replaceable optics, you define the light distribution of CURLING: Included in the scope of delivery is a real-glass diffuser lens for uniform, soft direct and ambient light. Optionally available is the anti-glare optic for intensive ambient light and strong but glare-free direct light or a microprismatic optic for directional direct light with a beam angle of 65°.

Passend für  
Suitable for

CURLING S / M / L

Abbildung figure	Beschreibung description	Art.-Nr. art.-no.	€ netto DE excl. VAT	€ brutto DE incl. VAT
	<b>Optik S abgeblendet</b> Optic S deglared	CU8532	21,01 €	25,00 €
	<b>Optik S Mikroprismatik</b> Optic S microprismatic	CU8539	25,21 €	30,00 €
	<b>Optik M abgeblendet</b> Optic M deglared	CU8535	35,29 €	42,00 €
	<b>Optik M Mikroprismatik</b> Optic M microprismatic	CU8536	40,34 €	48,00 €
	<b>Optik L abgeblendet</b> Optic L deglared	CU8537	42,02 €	50,00 €
	<b>Optik L Mikroprismatik</b> Optic L microprismatic	CU8541	47,90 €	57,00 €

## SPIEGEL ADAPTER SET / MIRROR ADAPTER SET



Material  
material

Kunststoffgewindeeinsätze zur Montage auf Echtglasspiegel (bis 8 mm Glasstärke)  
plastic thread insert for mounting on glass mirror (up to 8 mm glass thickness)

Passend für  
Suitable for

APP Wall, CAVITY Wall, CRIB Wall, LID Wall, SML Wall, SML<sup>2</sup> Wall  
(jeweils alle Größen bzw. Längen) / (all sizes each)

Abbildung figure	Beschreibung description	Art.-Nr. art.-no.	€ netto DE excl. VAT	€ brutto DE incl. VAT
	Set	ZB1001	37,82 €	45,00 €

## WALL ADAPTERS / WANDADAPTER

SML<sup>2</sup> Wall

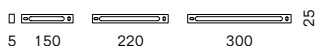

<b>Material</b> material	<b>Aluminium silber, schwarz, weiß lackiert oder poliert</b> aluminium coated silver, black, white or polished
<b>Sonstiges</b> features	<b>Montagehilfe bei nicht mittigem Stromanschluss; weitere Längen auf Anfrage</b> mounting aid for centered power connection; other lengths on request
<b>Passend für</b> Suitable for	<b>SML<sup>2</sup> Wall 150, 220, 300; weitere Längen auf Anfrage</b> SML <sup>2</sup> Wall 150, 220, 300; other lengths on request

Abbildung figure	Beschreibung description	Art.-Nr. art.-no.	€ netto DE excl. VAT	€ brutto DE incl. VAT
●	<b>150 silber</b> 150 silver	SM8801	23,53 €	28,00 €
○	<b>150 weiß</b> 150 white	SM8802	23,53 €	28,00 €
●	<b>150 schwarz</b> 150 black	SM8803	23,53 €	28,00 €
●	<b>150 poliert</b> 150 polished	SM8804	23,53 €	28,00 €
●	<b>220 silber</b> 220 silver	SM8805	26,89 €	32,00 €
○	<b>220 weiß</b> 220 white	SM8806	26,89 €	32,00 €
●	<b>220 schwarz</b> 220 black	SM8807	26,89 €	32,00 €
●	<b>220 poliert</b> 220 polished	SM8808	26,89 €	32,00 €
●	<b>300 silber</b> 300 silver	SM8809	29,41 €	35,00 €
○	<b>300 weiß</b> 300 white	SM8810	29,41 €	35,00 €
●	<b>300 schwarz</b> 300 black	SM8811	29,41 €	35,00 €
●	<b>300 poliert</b> 300 polished	SM8812	29,41 €	35,00 €

# WALL COVER / WANDABDECKUNGEN

REFLEX<sup>2</sup> Wall

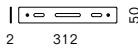

SML Wall

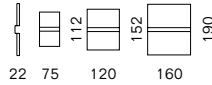

SML<sup>2</sup> Wall

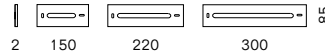

**Sonstiges** zur Abdeckung von z.B Anschlussdosen  
features to cover e.g. junction boxes

REFLEX <sup>2</sup> Wall				
Abbildung figure	Beschreibung description	Art.-Nr. art.-no.	€ netto DE excl. VAT	€ brutto DE incl. VAT
●	<b>schwarz</b> black	RE8520	29,41 €	35,00 €
○	<b>weiß</b> white	RE8521	29,41 €	35,00 €

SML Wall				
Abbildung figure	Beschreibung description	Art.-Nr. art.-no.	€ netto DE excl. VAT	€ brutto DE incl. VAT
●	<b>S silber eloxiert</b> S silver anodized	SM1053	31,09 €	37,00 €
●	<b>S glanzverchromt</b> S chrome-plated	SM3053	45,38 €	54,00 €
●	<b>M silber eloxiert</b> M silver anodized	SM1054	32,77 €	39,00 €
●	<b>M glanzverchromt</b> M chrome-plated	SM3054	50,42 €	60,00 €
●	<b>L silber eloxiert</b> L silver anodized	SM1055	37,82 €	45,00 €
●	<b>L glanzverchromt</b> L chrome-plated	SM3055	54,62 €	65,00 €

SML <sup>2</sup> Wall				
Abbildung figure	Beschreibung description	Art.-Nr. art.-no.	€ netto DE excl. VAT	€ brutto DE incl. VAT
●	<b>150 silber</b> 150 silver	SM4053	33,61 €	40,00 €
○	<b>150 weiß</b> 150 white	SM4056	33,61 €	40,00 €
●	<b>150 schwarz</b> 150 black	SM4059	33,61 €	40,00 €
●	<b>150 poliert</b> 150 polished	SM4062	33,61 €	40,00 €
●	<b>220 silber</b> 220 silver	SM4054	37,82 €	45,00 €
○	<b>220 weiß</b> 220 white	SM4057	37,82 €	45,00 €
●	<b>220 schwarz</b> 220 black	SM4060	37,82 €	45,00 €
●	<b>220 poliert</b> 220 polished	SM4052	37,82 €	45,00 €
●	<b>300 silber</b> 300 silver	SM4055	42,02 €	50,00 €
○	<b>300 weiß</b> 300 white	SM4058	42,02 €	50,00 €
●	<b>300 schwarz</b> 300 black	SM4061	42,02 €	50,00 €
●	<b>300 poliert</b> 300 polished	SM4048	42,02 €	50,00 €





# Information



Unsere Produkte sind so konstruiert, dass beim Austausch von Lichtquellen nur eine qualifizierte Fachkraft sicherstellen kann, dass diese nicht verunreinigt und/oder beschädigt werden. Die Lebensdauer der Lichtquellen wird durch die Montageart mit Wärmeleitpads unmittelbar beeinflusst. Daher wird der nicht fachmännische Austausch von Lichtquellen und separaten Betriebsgeräten als nicht sinnvoll angesehen.

Our products are designed in such a way that when light sources are replaced, only a qualified specialist can ensure that they are not contaminated and/or damaged. The service life of the light sources is directly affected by the mounting method with heat conducting pads. Therefore, the non-professional replacement of light sources and separate control gear is not considered advisable.

\* **Sonderausführungen mit anderen Lichtleistungen, Farbwiedergabeindizes, Oberflächen, Kabel- und Rohrlängen auf Anfrage.**  
Special versions products with other light outputs, colour rendering indices, surfaces, cable and tube lengths on request.

TRIAC **Diese Leuchten sind mit einem handelsüblichen Phasenabschnittsdimmer regelbar – sie können sowohl ein- und ausgeschaltet als auch in der Helligkeit stufenlos geregelt werden. Dafür ist eine 3-adrige Standard-Netzzuleitung ausreichend.**  
Luminaires with this feature can be controlled with a standard phase cut dimmer – it can be switched on and off as well as continuously be controlled in brightness. A 3-wire standard mains cable is sufficient.

DALI **5-adrige Netzzuleitung bei Regelung über DALI oder 0/1–10 V erforderlich.**  
0–10 V 5-core mains cable required for control via DALI or 0/1–10 V.  
1–10 V

CCT **LED-Leuchten mit einer Farbtemperatur von 2700 K liefern wir kurzfristig.**  
**LED-Leuchten mit einer Farbtemperatur von 3000 K und höher haben in der Regel längere Lieferzeiten.**  
We supply LED lights with a colour temperature of 2700 K at short notice.  
LED lights with a color temperature of 3000 K and higher usually have longer delivery times.

Lumen **Die Angaben zu Lichtstrom (Lumen) sind Nominalwerte, das heißt reine Modul-Lichtstromwerte.**  
**Der Lichtstrom gibt an, wieviel Licht nach allen Seiten abstrahlt.**  
The luminous flux (lumen) specifications are nominal values, i.e. pure module luminous flux values.  
The luminous flux indicates how much light radiates in all directions.

D2W **Mit Dim2Warm wird eine Funktionalität der Leuchte bezeichnet, mit der das als angenehm empfundene Dimmverhalten von klassischen Glühfadenlampen imitiert wird. Beim Dimmen wird das Licht nicht nur dunkler, sondern ändert seine Lichtfarbe auch in den warmweißen Bereich.**  
Dim2Warm refers to a luminaire functionality that imitates the pleasant dimming behavior of classic incandescent lamps. When dimmed, the light not only becomes darker, but also changes its colour to warm white tone.

TW **Leuchten mit der Tunable White Funktionalität besitzen eine variable Farbtemperatursteuerung von warm- bis kaltweißem Licht.**  
Luminaires with the tunable-white functionality have variable colour temperature control from warm to cool white light.

CRI **Der Farbwiedergabeindex wird zur Beurteilung der Qualität der Farbwiedergabe einer Lichtquelle herangezogen.**  
The colour rendering index is used to assess the quality of the colour rendering of a light source.

UGR **Bewertung der Blendung**  
Unified Glare Rating

+C **+C kennzeichnet Produkte, in die ein vorprogrammiertes CASAMBI-Modul integriert ist.**

Die CASAMBI Funktionalität ist grundsätzlich für alle unsere Produkte einsetzbar. Für die verschiedenen Integrationsmöglichkeiten (abhängig von der Temperatur: in die Leuchte, in die abgehängte Decke, in den Schalter oder den Verteilerkasten) informieren wir Sie gerne. CASAMBI ist ein Bluetooth-basiertes Lichtsteuerungssystem, das vollständig in die Leuchte oder hinter den Schalter integriert werden kann. Es ist einfach und intuitiv über mobile Devices mit der kostenlosen CASAMBI-App (iOS und Android) bedienbar. CASAMBI erweitert so die Steuerungsmöglichkeiten um Funktionen wie Dimmen, Gruppieren von Leuchten, Programmieren von Gruppen und Szenen, Automatisierungen und vieles mehr. Für ausführlichere Informationen besuchen Sie bitte [www.casambi.com](http://www.casambi.com)

+C indicates products with pre-programmed CASAMBI module integrated in the luminaire.

The CASAMBI functionality is basically applicable to all our products. For the different possibilities of integration (depending on the temperature) – in the luminaire, in the suspended ceiling, in the switch or the distribution box) we will be pleased to inform you. CASAMBI is a lighting control system which is operated via Bluetooth and can be integrated completely into the luminaire or behind the light switch. It is controlled via mobile devices using the free CASAMBI app, making its operation simple and intuitive. CASAMBI expands the possibilities of control with new options such as dimming, the programming of specific scenarios or groups, automations and many more. For further information, please visit [www.casambi.com](http://www.casambi.com).



**Eine Excel-Datei mit Artikelnummern und aktuellen Preisen stellen wir unseren Handelspartnern gerne zur Verfügung unter: [www.serien.com/downloads/](http://www.serien.com/downloads/)**

We are happy to make the Excel file with article numbers and current prices available to our trade partners:  
[www.serien.com/downloads](http://www.serien.com/downloads)



**Unter [www.serien.com/downloads](http://www.serien.com/downloads) finden Sie hilfreiche Informationen und die jeweils aktuellen technischen Daten: Datenblätter, Kataloge, Preislisten, Lichttechnische Daten (EULUMDAT), 3D CAD-Daten, Konformitätserklärungen, Retourenformular, FAQs, Montageanleitungen, Bohrschablonen und weitere Serviceanleitungen**

At [www.serien.com/downloads](http://www.serien.com/downloads) you will find helpful information and the latest technical data:  
Data sheets, catalogues, price lists, lighting data (EULUMDAT), 3D CAD data, declarations of conformity, returns form, FAQs, assembly instructions, drilling templates and other service instructions.

# Awards

## ANNEX

2013	German Design Award, Nominierung
2012	Design Plus
2011	Internationaler Designpreis Baden-Württemberg, Focus Silber

## APP

2017	German Design Award, Special Mention
2016	Design Plus
2016	Iconic Award, Interior Innovation, Winner

## CAVITY

2019	German Design Award, Winner
2019	Nominierung Leuchte des Jahres

## CURLING

2020	Innovationspreis Architektur+Technik
2018	German Design Award, Winner
2016	Internationaler Designpreis Baden-Württemberg, Focus Silber
2016	Iconic Award, Interior Innovation, Best of Best

## CRIB

2019	German Design Award, Winner
------	-----------------------------

## ELANE

2012	Deutscher Designer Club, Gute Gestaltung, Bronze
------	--

## JOB

2011	Designpreis der Bundesrepublik Deutschland, Nominierung
2010	Deutscher Designer Club, Gute Gestaltung, Silber
2009	The Israel Museum, Collection

## JONES

1999	Red Dot Design Award
------	----------------------

## LID

2018	Iconic Award, Innovative Interior, Best of Best
------	---

## ONE EIGHTY

2011	Designpreis der Bundesrepublik Deutschland, Nominierung
2010	Red Dot Design Award, Winner

## PROPELLER

2009	Designpreis der Bundesrepublik Deutschland, Nominierung
2009	The Israel Museum, Collection
2008	Red Dot Design Award, Winner

## REEF

2006	Designpreis der Bundesrepublik Deutschland, Nominierung
2004	Red Dot Design Award, Winner
2004	Design Plus
2004	Designpreis der Bundesrepublik Deutschland, Nominierung
2003	Internationaler Designpreis Baden-Württemberg, Focus Silber

## ROD

2019	Iconic Award, Innovative Interior, Best of Best
------	---

## REFLEX<sup>2</sup>

2022	Internationaler Designpreis Baden-Württemberg, Special Mention
2022	German Design Award, Winner (Floor)
2022	Iconic Award, Innovative Interior, Best of Best
2021	Stylepark Selected
2021	Internationaler Designpreis Baden-Württemberg, Special Mention
2020	Design Plus
2020	German Design Award, Winner (Ceiling)

## SEVENTY SEVEN

1991	iF Product Award
1991	Stedelijk Museum Amsterdam, Collection

## SLANT

2013	German Design Award, Nominierung
2012	Deutscher Designer Club, Gute Gestaltung, Silber

## SLICE

2015	German Design Award, Nominierung
------	----------------------------------

## SLICE<sup>2</sup> PI

2023	Internationaler Designpreis Baden-Württemberg, Focus Gold
------	---

## SML

2006	Designpreis der Bundesrepublik Deutschland, Nominierung
2004	Red Dot Design Award, Winner
2004	Designpreis der Bundesrepublik Deutschland
2003	Internationaler Designpreis Baden-Württemberg, Focus Silber

## SML<sup>2</sup>

2014	German Design Award, Nominierung
2013	Designpreis der Bundesrepublik Deutschland, Nominierung
2013	Red Dot Design Award, Winner

## SML T5

2004	Design Plus
2004	Designpreis der Bundesrepublik Deutschland
2004	iF Product Award, Winner
2003	Internationaler Designpreis Baden-Württemberg, Focus Silber

## TWIN

2015	German Design Award, Gold
2014	Design Plus

## ZOOM

2007	Designpreis der Bundesrepublik Deutschland, Nominierung
2004	Designpreis der Bundesrepublik Deutschland, Nominierung
2003	Red Dot Design Award, Winner
2003	Internationaler Designpreis Baden-Württemberg, Focus Gold

# Service

Bei Fragen zu unseren Produkten, deren Lieferbedingungen und Verfügbarkeiten kontaktieren Sie bitte unser Serviceteam.

For questions about our products, their delivery conditions and availabilities, please contact our customer service any time.

+49 6106 6909 0  
serien@serien.com  
www.serien.com

## Business Contacts

### Gebiet Nord/Ost

PLZ 0, 1 - 39  
PLZ 99

serien Raumeuchten GmbH  
Dzenan Ganibegovic

Hainhäuser Straße 3-7  
63110 Rodgau  
Germany

E dzenan.ganibegovic@serien.com  
M +49 151 5122 1212  
T +49 6106 6909 248

### Gebiet West/Mitte

West PLZ 48 - 49 und 57 - 59  
Mitte PLZ 60 - 65

serien Raumeuchten GmbH  
Dzenan Ganibegovic

Hainhäuser Straße 3-7  
63110 Rodgau  
Germany

E dzenan.ganibegovic@serien.com  
M +49 151 5122 1212  
T +49 6106 6909 248

### Gebiet West/Süd

West PLZ 40 - 47 und 50 - 56  
Süd PLZ 66 - 98

serien Raumeuchten GmbH  
Helmuth Grischy

Hainhäuser Straße 3-7  
63110 Rodgau  
Germany

E helmuth.grischy@serien.com  
M +49 151 5092 8656  
T +49 6106 6909 252

### Austria

serien Raumeuchten GmbH  
Peter Salat

Hainhäuser Straße 3-7  
63110 Rodgau  
Deutschland

E peter.salat@serien.com  
M +49 179 496 57 43  
T +49 6106 6909 232

### Switzerland

wirzpartner GmbH  
für Leuchten und Licht

Werner-Weber-Str. 11  
8630 Rüti  
Schweiz

E info@wirzpartner.ch  
M +41 79 290 30 08  
T +41 55 260 19 60

### Benelux

serien Raumeuchten GmbH

Hainhäuser Straße 3-7  
63110 Rodgau  
Germany

E serien@serien.com  
T +49 6106 6909 0

### Brasil

FAS iluminação

Alameda Gabriel Monteiro da Silva,  
n° 413 Jardim America  
00.817.414/0001-08 – São Paulo  
Brazil

E atendimento@fasiluminacao.com.br  
T +55 11 30861661  
M +55 11 94713-9743

### Australia

Archebiosis Architects  
Edith Clark

Shop 3B, 780 Bourke Street  
NSW 2016 Redfern  
Australia

E edith@archebiosis.com  
T +61 2 83992334

### Greece & Cyprus

Christos Keletzis

Werrastr. 42  
60486 Frankfurt  
Germany

E christos.keletzis@serien.com  
T +49 171 5725684

### Portugal

In-One  
Manuela Peres

EN 125  
8100-068 Benfarras/Boliqueime  
Portugal

E manuelaperes@in-one.pt  
T +35 1938460199

### Worldwide

We are distributing worldwide.

Please contact our customer  
service for more information:

E serien@serien.com  
T +49 6106 6909 0

## Impressum Imprint

serien Raumluchten GmbH, HRB 22042 Amtsgericht Offenbach. Geschäftsführer/Managing Directors: Jean-Marc da Costa, Manfred Wolf. Copyright: serien Raumluchten GmbH 2023. **Alle Rechte vorbehalten. Keine Reproduktionen ohne vorherige schriftliche Zustimmung. Alle Marken sind registriert. Alle Produkte sind gesetzlich geschützt. Verstöße werden in vollem Umfang strafrechtlich verfolgt. Änderungen vorbehalten.** All rights reserved. No reproductions without prior written consent. All trademarks are registered. All products are protected by law. Infringements will be prosecuted to the fullest extent. Subject to alteration without notice. **Konzeption** Concept: serien.lighting; **Projektleitung** Projektmanagement: Nina da Costa **Gestaltung** Graphic Design: Sandra Doeller; **Renderings** serien.lighting – preyer3d.de **Postproduction** David Helmrich, Sebastian Hübner, Peter Schladoth, Nicola Riva **Druck** Printing: pruskil

## THANK YOU to hosts, artists and photographers:

**Cover Foto** Haus B, München DE – Studio Olaf Becker; **04 ANNEX** Ceiling: products – Christoph Lison; **06 CAVITY** Ceiling: products – serien.lighting; **08 CURLING** Ceiling: products – Christoph Lison, 3D serien.lighting; **12 DRAFT** Ceiling: products – serien.lighting, preyer3d.de; **26 ANNEX** Ceiling: products – Christoph Lison; **27 ANNEX** Ceiling M: Next Munich GmbH, München DE – Studio Olaf Becker; **28 ANNEX** Ceiling M: Privat, Frankfurt am Main DE – Christoph Lison; **29 ANNEX** Ceiling M: Frank Landau, Frankfurt am Main DE – Farideh Fotografie; **30 ANNEX** Ceiling L: Seven Swans, Frankfurt am Main DE – Ingmar Kurth; **31 ANNEX** Ceiling M: Universitätsbibliothek Bern, Bern CH – Studio Olaf Becker; **33 CAVITY** Ceiling S: appartement/showroom, Bayern DE, www.stephanie-thatenhorst.com – Studio Olaf Becker; **34 CURLING** Ceiling M: Privat, Frankfurt am Main DE – Farideh Fotografie; products – Christoph Lison, 3D serien.lighting; **35 CURLING** Ceiling M: Privat, Frankfurt am Main DE – Farideh Fotografie; **36/37 CURLING** Ceiling S: hauser lacour, Frankfurt am Main DE – Farideh Fotografie; **38/39 CURLING** Ceiling M: Himmelrich, Luzern CH – Studio Olaf Becker; **40 DRAFT** Ceiling: products – serien.lighting, preyer3d.de; **41 DRAFT** Ceiling M: Privat, Stuttgart DE, www.nowherearchitekten.de – Studio Olaf Becker; **42 DRUM** Ceiling: products – serien.lighting, preyer3d.de; **43 DRUM** Ceiling M short: Privat, Brüssel BE – Studio Olaf Becker; **44 DRUM** Ceiling M long: Privat, Stuttgart DE, www.nowherearchitekten.de – Studio Olaf Becker; **45 DRUM** Ceiling M short: Office, Bozen IT – Studio Olaf Becker; **46 POPPY** Ceiling 5: Uli Holzinger, Frankfurt am Main DE – Ingmar Kurth; **47 REEF** Ceiling: Karl Henschel, Offenbach am Main – Ingmar Kurth; Product – Christoph Lison; **48 REFLEX<sup>2</sup>** Ceiling M 150: appartement/showroom, Bayern DE, www.stephanie-thatenhorst.com – Studio Olaf Becker; **49 REFLEX<sup>2</sup>** Ceiling M 300: Haus B, München DE – Studio Olaf Becker; **50 REFLEX<sup>2</sup>** Ceiling M 450: Product – serien.lighting, preyer3d.de; **51 REFLEX<sup>2</sup>** Ceiling S 600: Ingmar Kurth, Frankfurt am Main DE; **52 REFLEX<sup>2</sup>** Ceiling M 450: Haus B, München DE – Studio Olaf Becker; **53 REFLEX<sup>2</sup>** Ceiling M 450: Haus B, München, DE – Studio Olaf Becker; **54 SLICE<sup>2</sup>** PI Ceiling: products – serien.lighting, preyer3d.de; **55 SLICE<sup>2</sup>** PI Ceiling: Ingmar Kurth; **58 ANNEX** Suspension: products – Christoph Lison; **60 CAVITY** Suspension: products – serien.lighting, preyer3d.de; **63 CURLING** Suspension: products – Christoph Lison, 3D serien.lighting; **66 DRAFT** Suspension: products – serien.lighting, preyer3d.de; **70 ONE EIGHTY** Suspension: products – Christoph Lison; **78 ANNEX** Suspension L: Prasad&Schwarck, Frankfurt am Main DE – Christoph Lison; **79 ANNEX** Suspension M: Next Munich GmbH DE – Studio Olaf Becker; **80 CAVITY** Suspension L: Bürgeramt der Stadt Frankfurt am Main DE, www.jacoby-architects.de – Studio Olaf Becker; **81 CAVITY** Suspension: products – serien.lighting, preyer3d.de; **82 CAVITY** Suspension S: Privat, Stuttgart DE, www.nowherearchitekten.de – Studio Olaf Becker; **83 CAVITY** Suspension S: Wohnung K, München, DE – Studio Olaf Becker; **84 CURLING** Suspension Rope L: Himmelrich, Luzern CH – Studio Olaf Becker; **85 CURLING** Suspension: products – serien.lighting, preyer3d.de; **86 DRAFT** Suspension Rope M: M4 Offices, München DE – Studio Olaf Becker; **87 DRAFT** Suspension Rope S/M: Privat, Stuttgart DE, www.nowherearchitekten.de – Studio Olaf Becker; **88 DRUM** Suspension Rope M: Ingmar Kurth, Frankfurt am Main DE; **89 DRUM** Suspension Tube M: Schule, München DE – Studio Olaf Becker; **90 ONE EIGHTY** Suspension L Adjustable: Moon Dog Studio, Frankfurt am Main DE – Ingmar Kurth; **91 ONE EIGHTY** Suspension L Adjustable: Restaurant Margarete, Frankfurt am Main DE – Christoph Lison; **92 POPPY** Suspension: Tony McNeveins, Wiesbaden DE – Ingmar Kurth; **93 PROPELLER**: Product – Christoph Lison; **94 REEF** Suspension 3: Moon Dog Studio, Frankfurt am Main DE – Ingmar Kurth; **95 TWIN**: Schmidt Apartment, Frankfurt am Main DE – Ingmar Kurth; **96 ZOOM** 3: MHK Küchen, Dreieich DE – Studio Olaf Becker; **97 ZOOM** 1: Privat, CH – Heinz Dahinden; **98 ZOOM XL**: bigstock.com – David Helmrich; **99 ZOOM XL** 2: Café Wacker, Frankfurt am Main DE – Jean-Marc da Costa; **102 APP** Wall: products – Christoph Lison; **104 CAVITY** Wall: products – serien.lighting, preyer3d.de; **107 CRIB** Wall: Products – serien.lighting, preyer3d.de; **108 CURLING** Wall: products – serien.lighting, preyer3d.de; **110 LID** Wall: products – serien.lighting, preyer3d.de; **116 REEF** Wall – Christoph Lison; **117 REFLEX** Wall: products – serien.lighting, preyer3d.de; **118 ROD** Wall: products – serien.lighting, preyer3d.de; **126 APP** Wall: Privat, Frankfurt am Main DE – Farideh Fotografie; **127 APP** Wall: Privat, Frankfurt am Main DE – Ingmar Kurth; **128 CAVITY** Wall S: Privat, Stuttgart DE, www.nowherearchitekten.de – Studio Olaf Becker; **129 CAVITY** Wall S: products – serien.lighting, preyer3d.de; **130 CLUB** Wall: Restaurant Margarete, Frankfurt am Main DE – Ingmar Kurth; **131 CURLING** Wall S/M: Haus B, München DE – Studio Olaf Becker; **132/133 CURLING** Wall M: Himmelrich, Luzern CH – Studio Olaf Becker; **134 CRIB** Wall: Ingmar Kurth, Frankfurt am Main DE; **135 CRIB** Wall: Haus B, München DE – Studio Olaf Becker; **136 LID** Wall IP44: Goethequartier, Offenbach DE – Christoph Lison; **137 LID** Wall: Office, Planegg DE, Ricardo Alves GmbH – Studio Olaf Becker; **138 LID** Wall: Privathaus, Budapest HU – Christoph Lison; **139 LID** Wall: products – serien.lighting, preyer3d.de; **140 POPPY** Wall 2: Uli Holzinger, Frankfurt am Main DE – Ingmar Kurth; **141 REEF** Wall: products – Christoph Lison; **142 REFLEX<sup>2</sup>** Wall 300 – Christoph Lison; **143 REFLEX<sup>2</sup>** Wall 300: products – serien.lighting, preyer3d.de; **144 ROD** Wall: Weingut Alfred Küchle, Frankfurt am Main DE – Ingmar Kurth; **145 ROD** Wall: Haus B, München DE – Studio Olaf Becker; **146 SML** Wall: Wohnung B, Berlin DE – Ingmar Kurth; **147 SML<sup>2</sup>** Wall 300: Universitätsbibliothek Bern, Bern CH – Studio Olaf Becker; **148 SML<sup>2</sup>** Wall 220: Soho Turley, Mannheim DE – Farideh Fotografie; **149 SML<sup>2</sup>** Wall 220: Shift, Frankfurt am Main DE – Christoph Lison; **150 SML** Wall: products – Christoph Lison; **151 SML** Wall: Bettmeralp, CH – Thomas Andenmatten; **155 REFLEX** Table: products – serien.lighting, preyer3d.de; **160 JOB** Table: Doris Fratton DE – Ingmar Kurth; **161 POPPY** Table: Juan Amador Suite DE – Christoph Lison; **162/163 REFLEX<sup>2</sup>** Table: Privat, Stuttgart DE, www.nowherearchitekten.de – Studio Olaf Becker; **164 SLICE<sup>2</sup>** Furniture Chrome: Office Westend, Frankfurt am Main DE – Christoph Lison; **165 SLICE<sup>2</sup>** Furniture Chrome: Zollverein School, Essen DE – Ingmar Kurth; **172 REFLEX<sup>2</sup>** Floor: products – serien.lighting, preyer3d.de; **178/179 CENTRAL** Floor: Privat, Frankfurt am Main DE – Ingmar Kurth; **180 CLUB** Floor: products – Christoph Lison; **181 CLUB** Floor: Haus B, München DE – Studio Olaf Becker; **182 CLUB** Floor: Haus B, München DE – Studio Olaf Becker; **183 CLUB** Floor: Wohnung K, München DE – Studio Olaf Becker; **184 JONES** Floor: Privat, Frankfurt am Main DE – Farideh Fotografie; **185 JONES** Floor: Privat, Frankfurt am Main DE – Farideh Fotografie; **186/187 POPPY** Floor: Liv Johansson Weicker, Darmstadt DE – Farideh Fotografie; **188 REFLEX<sup>2</sup>** Floor S: Wohnung K, München DE – Studio Olaf Becker; **189 REFLEX<sup>2</sup>** Floor M: Privat, Stuttgart DE, www.nowherearchitekten.de – Studio Olaf Becker; **190 REFLEX<sup>2</sup>** Floor S: Haus B, München DE – Studio Olaf Becker; **191 REFLEX<sup>2</sup>** Floor M: Weingut Alfred Küchle, Frankfurt am Main DE – Ingmar Kurth; **192/193 REFLEX<sup>2</sup>** Floor S 100: Privat, Stuttgart DE, www.nowherearchitekten.de – Studio Olaf Becker; **194 SLICE<sup>2</sup>** Floor: 2030 Agentur für Kommunikation, München DE – Studio Olaf Becker; **195 SLICE<sup>2</sup>** Floor: M4 Offices, München DE – Studio Olaf Becker; **198 DRAFT** Suspension M: Ingmar Kurth, Frankfurt am Main DE

**Mit Erscheinen dieser Preisliste verlieren alle bisherigen Preislisten ihre Gültigkeit. Die angegebenen Bruttopreise enthalten den zum Zeitpunkt der Drucklegung in Deutschland gültigen Mehrwertsteuersatz von 19%. Die dargestellten Produktzeichnungen dienen der Illustration. Auch wenn bei deren Erstellung mit großer Sorgfalt vorgegangen wurde, können einzelne Proportionen vom tatsächlichen Produkt abweichen. Alle Maße in Millimetern, sofern nicht anders angegeben. Für alle Aufträge gelten die Liefer- und Zahlungsbedingungen der serien Raumluchten GmbH. Änderungen und Irrtümer vorbehalten. Preisanpassungen sind auch während der Preislistenlaufzeit möglich.**

This price list supersedes all previously published price lists. The gross prices shown include the german value added tax rate of 19% valid at the time of printing. Retail prices may differ with local sales taxes applied. The drawings shown in this document are for informational purposes only. Although great care has been taken when creating them, their proportions may not correctly reflect the proportions of the real product. All dimensions are millimetres unless specifically declared otherwise. All orders are accepted subject to the Conditions of Sale of serien Raumluchten GmbH. Subject to alteration without notice. Prices may be adjusted during the period covered by the price list.





scan for PDF



@serien.lighting  
www.serien.com